

CECW-EH-D  Engineer Manual 1110-2-1607	Department of the Army U.S. Army Corps of Engineers Washington, DC 20314-1000	EM 1110-2-1607  15 March 1991
	Engineering and Design  TIDAL HYDRAULICS	
	<b>Distribution Restriction Statement</b> Approved for public release; distribution is unlimited.	

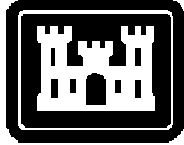

EM 1110-2-1607  
15 March 1991

**US Army Corps  
of Engineers**

**ENGINEERING AND DESIGN**

---

# **Tidal Hydraulics**

**ENGINEER MANUAL**

DEPARTMENT OF THE ARMY  
US Army Corps of Engineers  
Washington, DC 20314-1000

EM 1110-2-1607

CECW-EH-D

Engineer Manual  
No. 1110-2-1607

15 March 1991

Engineering and Design  
TIDAL HYDRAULICS

1. Purpose. This manual provides current guidance and engineering procedures for the solution of tidal hydraulics problems.
2. Applicability. This manual applies to HQUSACE/OCE elements, major subordinate commands, districts, laboratories, and field operating activities (FOA) having responsibility for design, construction, and operation of civil works projects within areas of tidal influence.
3. General. The subjects covered in this manual range from the fundamentals of estuarine engineering to specific problem solving techniques, including environmental considerations, to a summary of "lessons learned" from completed projects. The problem solving portion of the manual serves as a means of transferring the technical knowledge obtained from recent research efforts in tidal hydraulic engineering.

FOR THE COMMANDER:

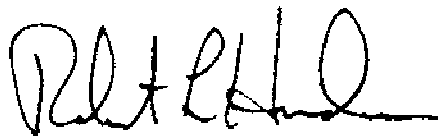

ROBERT L. HERNDON  
Colonel, Corps of Engineers  
Chief of Staff

Engineer Manual  
No. 1110-2-1607

15 March 1991

Engineering and Design  
TIDAL HYDRAULICS

## Table of Contents

	<u>Subject</u>	<u>Paragraph</u>	<u>Page</u>
CHAPTER 1	INTRODUCTION		
	Purpose-----	1-1	1-1
	Appendices-----	1-2	1-1
	Training-----	1-3	1-1
	Available Assistance-----	1-4	1-1
	References-----	1-5	1-1
CHAPTER 2	DEFINITION AND FORCING FUNCTIONS OF ESTUARIES		
Section I	Definition		
	Definition-----	2-1	2-1
Section II	Classification of Estuaries		
	General-----	2-2	2-1
	Classification-----	2-3	2-1
	Topographic Classification-----	2-4	2-1
	Classification by Salinity Structures-----	2-5	2-2
	Stratification Numbers-----	2-6	2-5
	Flow Predominance-----	2-7	2-6
	Null Point-----	2-8	2-6
	Salinity Effects on Shoaling-----	2-9	2-7
	Summary-----	2-10	2-7
Section III	Tides and Other Long Waves		
	Tide-Generating Forces-----	2-11	2-7
	Tide Terms-----	2-12	2-8
	Types of Basic Tides-----	2-13	2-8
	Spring and Neap Tides-----	2-14	2-9
	Influence of Moon and Sun-----	2-15	2-9
	Tide Prediction Tables-----	2-16	2-9
	Tidal Constituents-----	2-17	2-9
	Nonastronomical Forces-----	2-18	2-9
	Waveforms-----	2-19	2-11

---

This manual supersedes EM 1110-2-1607, 21 August 1965.

	<u>Subject</u>	<u>Paragraph</u>	<u>Page</u>
Section IV	Winds and Wind-Generated Waves		
	General-----	2-20	2-11
	Wind Effects-----	2-21	2-11
	Setup and Setdown-----	2-22	2-11
	Seiche-----	2-23	2-12
	Storm Surge-----	2-24	2-12
Section V	Freshwater Inflow		
	Freshwater Sources-----	2-25	2-12
	Episodic Events-----	2-26	2-12
Section VI	Changes in Sea Level		
	Sea Level Rise-----	2-27	2-12
	Apparent Sea Level Rise-----	2-28	2-13
Section VII	Summary		
	Classifying an Estuary-----	2-29	2-13
CHAPTER 3	HYDRODYNAMIC ANALYSIS OF ESTUARIES		
Section I	Factors Influencing Hydrodynamics		
	Introduction-----	3-1	3-1
	Tides-----	3-2	3-1
	Freshwater Inflow-----	3-3	3-1
	Salinity-----	3-4	3-1
	Coriolis Force-----	3-5	3-1
	Geometric Influences-----	3-6	3-1
	Seiching-----	3-7	3-2
	Temperature-----	3-8	3-2
Section II	Solution Methods		
	General-----	3-9	3-2
	Field Observations-----	3-10	3-2
	Analytical Solution Methods-----	3-11	3-3
	Numerical Modeling-----	3-12	3-3
	Physical Models-----	3-13	3-4
	Hybrid Method-----	3-14	3-5
CHAPTER 4	SEDIMENTATION ANALYSIS OF ESTUARIES		
	Introduction-----	4-1	4-1
	Sediment Sources-----	4-2	4-1
	Sediment Classification-----	4-3	4-1
	Coarse Sediment Transport-----	4-4	4-2
	Cohesive Sediment Transport-----	4-5	4-4
	Impact of Tidal Flow and Geometry-----	4-6	4-6
	Sediment Characterization-----	4-7	4-7
	Transport Parameters-----	4-8	4-9

<u>Subject</u>		<u>Paragraph</u>	<u>Page</u>
	Causes of Sediment Deposition-----	4-9	4-10
	Consolidation-----	4-10	4-11
	Physical Models-----	4-11	4-11
	Analytical Models-----	4-12	4-12
	Numerical Models-----	4-13	4-12
	Hybrid Models-----	4-14	4-13
	Field Data Requirements-----	4-15	4-13
CHAPTER 5	DESIGN CONSIDERATIONS		
Section I	Control Works		
	Purpose-----	5-1	5-1
	Types-----	5-2	5-1
Section II	Design Factors		
	General-----	5-3	5-7
	Navigation Safety-----	5-4	5-7
	Salinity-----	5-5	5-8
	Water Quality-----	5-6	5-8
	Channel Sedimentation-----	5-7	5-8
	General Sedimentation-----	5-8	5-8
Section III	Siting of Control Works		
	Flooding-----	5-9	5-8
	Estuarine Breakwaters and Jetties-----	5-10	5-8
	Salinity Barriers-----	5-11	5-9
	Hurricane Barriers-----	5-12	5-11
	Training Dikes-----	5-13	5-11
	Revetments-----	5-14	5-12
	Diversion Works-----	5-15	5-12
	Sediment Traps-----	5-16	5-13
Section IV	Maintenance Dredging		
	Dredging Plant-----	5-17	5-14
	Advance Maintenance Dredging-----	5-18	5-15
	Agitation Dredging-----	5-19	5-17
	Vertical Mixers and Air Bubblers-----	5-20	5-18
	Rakes and Drag Beams-----	5-21	5-18
	Water Jets-----	5-22	5-19
Section V	Case Histories		
	Description-----	5-23	5-19
	Contents-----	5-24	5-19
	Lessons Learned-----	5-25	5-20
	Physical Model Studies-----	5-26	5-20

	<u>Subject</u>	<u>Paragraph</u>	<u>Page</u>
CHAPTER 6	ENVIRONMENTAL CONSIDERATIONS		
	General-----	6-1	6-1
	Water Quality Considerations-----	6-2	6-5
	Biological Considerations-----	6-3	6-7
	Dredging Effects Considerations-----	6-4	6-7
	Environmental Data Collection and Analysis-----	6-5	6-8
	Mitigation Decision Analysis-----	6-6	6-8
	Checklist of Environmental Studies-----	6-7	6-10
APPENDIX A	BIBLIOGRAPHY		
APPENDIX B	FIELD DATA CONSIDERATIONS		
APPENDIX C	NUMERICAL MODEL INVESTIGATION OF THE SAVANNAH RIVER ESTUARY		
APPENDIX D	ESTUARINE SEDIMENTATION ANALYSIS		
APPENDIX E	EXCERPTS FROM "LESSONS LEARNED"		
APPENDIX F	A SELECTED COMPILATION OF TIDAL HYDRAULIC MODEL INVESTIGATIONS		

## CHAPTER 1

### INTRODUCTION

1-1. Purpose. This manual provides design guidance for the development or improvement of navigation and flood control projects in estuaries. Factors are presented that should be considered in providing safe and efficient navigation facilities with least construction and maintenance costs and/or providing protection from design floods. Considerations for preventing damage to the environmental quality of the estuary are also presented. The design engineer is expected to adopt the general guidance presented in this manual to specific projects. Deviations from this guidance are acceptable if adequately substantiated. It should be noted that coastal structures and approach channels are not included in this manual.

1-2. Appendices. Appendix A is the alphabetical listing of references cited in this manual. Appendix B discusses field data collection considerations along with an example. Appendix C presents an example numerical model investigation. Appendix D presents greater details of sedimentation analysis than provided in Chapter 4. Appendix E is a summary of generic or overall lessons learned from various Corps navigation projects, and Appendix F is a listing of tidal model investigations conducted at the US Army Engineer Waterways Experiment Station (WES). Appendices B through F have been included to provide general guidance and examples.

1-3. Training. The US Army Engineer Division, Huntsville, offers a short-term (1-week) training course entitled "Hydraulic Design for Tidal Waterways" (formerly called "Tidal Hydraulics") within the Proponent Sponsored Engineer Corps Training Program (PROSPECT). The course covers the latest engineering and design considerations for the development and improvement of Corps projects in tidal waters as contained in this manual. Other related courses on the TABS numerical modeling system, referenced in several of the chapters and appendices, are also listed in the PROSPECT Purple Book. Several other PROSPECT courses also are available on various topics directly related to tidal hydraulics. Interested Corps employees should check with their supervisor or Training Officer and the Purple Book for required qualifications and prerequisites for the particular training course. If qualified, the employee should follow the standard training application procedure for his or her District or Division.

1-4. Available Assistance. The USACE Committee on Tidal Hydraulics (CTH) provides expert consultation on problems related to tidal hydraulics. Address inquiries to the Chairman, CTH, WES, ATTN: CEWES-HV-Z, 3909 Halls Ferry Road, Vicksburg, MS 39180-6199.

1-5. References. Required references are listed as follows. Related references are listed in Appendix A.

a. EM 1110-2-1202 (Environmental Engineering for Deep-Draft Navigation Projects).



EM 1110-2-1607  
15 Mar 91

- b. EM 1110-2-1412 (Storm Surge Analysis and Design Water Level Determination).
- c. EM 1110-2-1611 (Layout and Design of Shallow Draft Waterways).
- d. EM 1110-2-1613 (Hydraulic Design of Deep-Draft Navigation Projects).
- e. EM 1110-2-5025 (Dredging and Dredged Material Disposal).
- f. ER 1105-2-50 (Environmental Resources).
- g. ER 1110-2-1404 (Deep-Draft Navigation Project Design).
- h. ER 1110-2-1457 (Hydraulic Design of Small Boat Navigation).
- i. ER 1110-2-1458 (Hydraulic Design of Shallow Draft Navigation Projects).

## CHAPTER 2

### DEFINITION AND FORCING FUNCTIONS OF ESTUARIES

#### Section I. Definition

2-1. Definition. An estuary is an area of interaction between salt and fresh water. The most common definition used is that of Cameron and Pritchard (1963) that states, "An estuary is a semi-enclosed coastal body of water which has a free connection with the open sea and within which sea water is measurably diluted with fresh water derived from land drainage." Hopkinson and Hoffman (1983) argue that the estuarine influence may extend to the nearshore coastal waters where seawater is diluted by land drainage but beyond the confines of emergent land masses. Using the Cameron-Pritchard definition, the brackish waters of the Amazon and Mississippi Rivers seaward of the river mouths are not estuarine; using the Hopkinson-Hoffman definition, they are. Hopkinson and Hoffman support, from a functional point of view, the extension of the estuarine boundary to include the interface system that couples continent to ocean.

#### Section II. Classification of Estuaries

2-2. General. To more fully understand what an estuary is, some sort of classification system must be established. Pritchard's definition is one for a positive estuary (Pritchard 1952a), an estuary where freshwater input (river flow and precipitation) exceeds losses due to evaporation. Thus the surface salinities in a positive estuary are lower than in the open ocean. A situation in which freshwater input is less than losses due to evaporation results in a negative estuary, such as Laguna Madre in Texas. Most estuaries are positive; however, a negative situation can occur, resulting in different circulation patterns caused by hypersaline conditions.

2-3. Classification. Estuaries are also classified by topography and salinity structure. Ratio parameters of flow, stratification, and stratification-circulation can be used to identify the salinity structure class.

2-4. Topographic Classification. Pritchard (1952b) has suggested a topographic classification of three groups: coastal plain estuaries, fjords, and bar-built estuaries.

a. Coastal Plain Estuaries. Coastal plain estuaries, or drowned river valleys, were formed as the melting waters from the last ice age flooded the existing river valleys. River flow is normally small compared to tidal prism (the volume of water between high and low tides) and sedimentation has not kept pace with inundation. The resulting estuary has maintained the topography of the former river valley but is relatively shallow (rarely deeper than 100 feet (30 metres)). There are extensive mud flats with a sinuous, deeper central channel. Coastal plain estuaries are generally found in temperate latitudes. Examples are the Chesapeake Bay estuary system in the United States and the Thames and Mersey systems in England.

b. Fjords. Fjords, estuaries that have been formed by glacial erosion, generally occur at higher latitudes, are relatively long and deep, and possess a shallow sill at the fjord mouth and fjord intersections. These shallow sills can restrict the free exchange of ocean and estuary waters, in some cases producing a small tidal prism with respect to river flow. Examples of fjords are Puget Sound (United States), Alberni Inlet (British Columbia, Canada), Sogne Fjord (Norway), and Milford Sound (New Zealand).

c. Bar-built Structures. Bar-built estuaries are formed by the same processes as the drowned river valleys, the difference being that sedimentation has kept pace with inundation, with a characteristic bar forming at the mouth. Associated with depositional areas, bar-built estuaries are shallow with extensive lagoons and waterways inside the mouth. Entrance velocities can be quite high but quickly diminish as the estuary widens. This type of high sediment volume estuary is most often found in tropical or active coastal deposition areas. Examples of bar-built estuaries are the Roanoke River (United States) and the Vellar Estuary (India).

d. Other. A fourth group of estuaries would be those not belonging to the previously mentioned three. This group would include estuaries formed by volcanic eruptions, faulting, landslides, or other processes.

2-5. Classification by Salinity Structures. Most estuary systems are coastal plain estuaries with individually unique salinity and flow characteristics. To understand the circulation of these estuaries, Pritchard (1955) and Cameron and Pritchard (1963) have classified estuaries using stratification and salinity distribution as the governing criteria. The major classifications are highly stratified, partially mixed, and well-mixed (homogeneous) (Figure 2-1).

a. Highly Stratified. A highly stratified, salt wedge type estuary is one in which the outgoing lighter fresh water overrides a dense incoming salt layer. The dense salt wedge will advance along the bottom until the freshwater flow forces can no longer be overcome. At this point, the tip of the salt wedge will be blunt during rising tide and tapered during falling tide. Mixing occurs at the saltwater/freshwater interface by entrainment, a process caused by shear forces between the two moving layers. As small amounts of dense water are mixed in the upper layers, more fluid enters the estuary near the bottom to compensate for the loss, and more fluid leaves the estuary in the upper layers to attain equilibrium of forces (Figure 2-2a). In these river-dominated, poorly mixed estuaries, such as Southwest Pass on the Mississippi River, upstream flow occurs in the salt wedge regardless of tidal phase, with downstream flow on the surface. In the shallower South Pass, also on the Mississippi River, upstream flow occurs in the wedge during flood tide simultaneously with surface downstream flow, while during ebb tide, flow at all depths is in the seaward direction (Wright 1971). Examples are the Mississippi River (United States) and Vellar Estuary (India). Another form of a highly stratified estuary is the fjord type system. Similar to the salt wedge type, in a fjord the lower, almost isohaline, layer is very deep. The freshwater surface layer is almost homogeneous, and only during low-flow periods does the maximum salinity gradient ever reach the surface. Circulation over

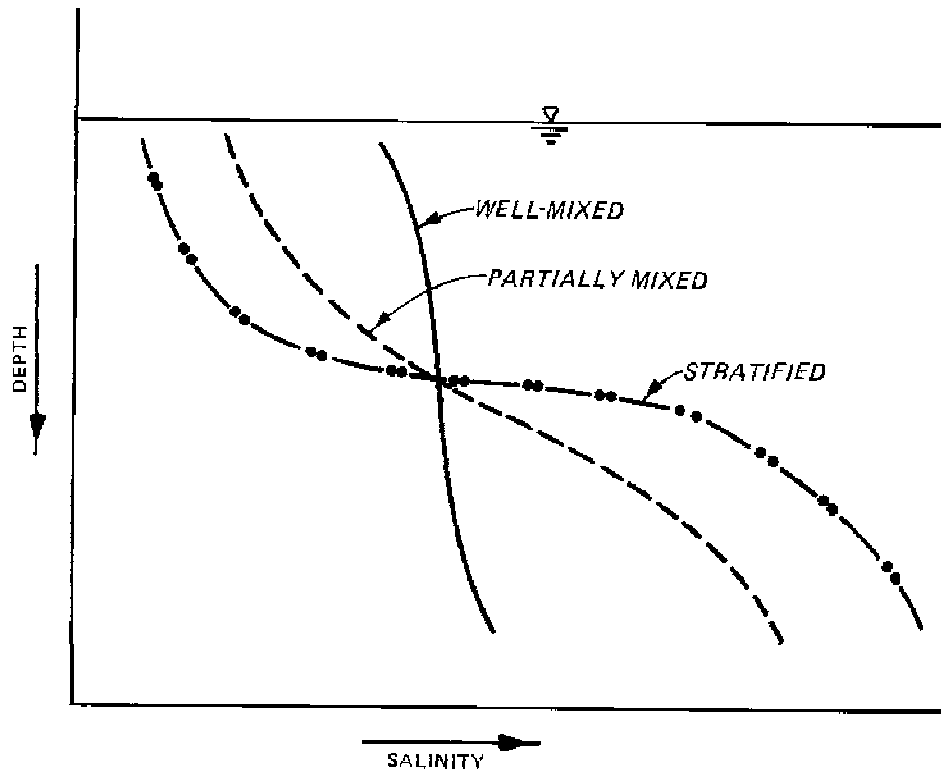

Figure 2-1. Vertical salinity structure. Classification depends on salinity difference between surface and bottom values

the sill may be very different from the rest of the fjord estuary because of large tidal velocities and weaker stratification at the sill. The inflow over the sill is usually a mixture of coastal and outflow water. As the water passes the sill and the tidal action decreases, the denser water settles and frequently results in a layered structure resulting from successive saltwater intrusions (Figure 2-2b). If water renewal is infrequent, anoxic conditions can develop on the bottom. Silver Bay (Alaska, United States) and Alberni Inlet (British Columbia, Canada) are examples.

b. Partially Mixed. A partially mixed estuary is one in which tidal energy is dissipated by bottom friction produced turbulence. These turbulent eddies mix salt water upward and fresh water downward with a net upward flow of saline water. As the salinity of the surface water is increased, the outgoing surface flow is correspondingly increased to maintain riverflow plus the additional upward-mixed saline water. This causes a compensating incoming flow along the bottom. This well-defined, two-layer flow is typical of partially mixed estuaries. The salinity structure is very different from a highly stratified estuary because of the efficient mixing of salt and fresh water. The surface salinity increases steadily down the estuary with undiluted fresh water now occurring only near the head of the estuary. There is

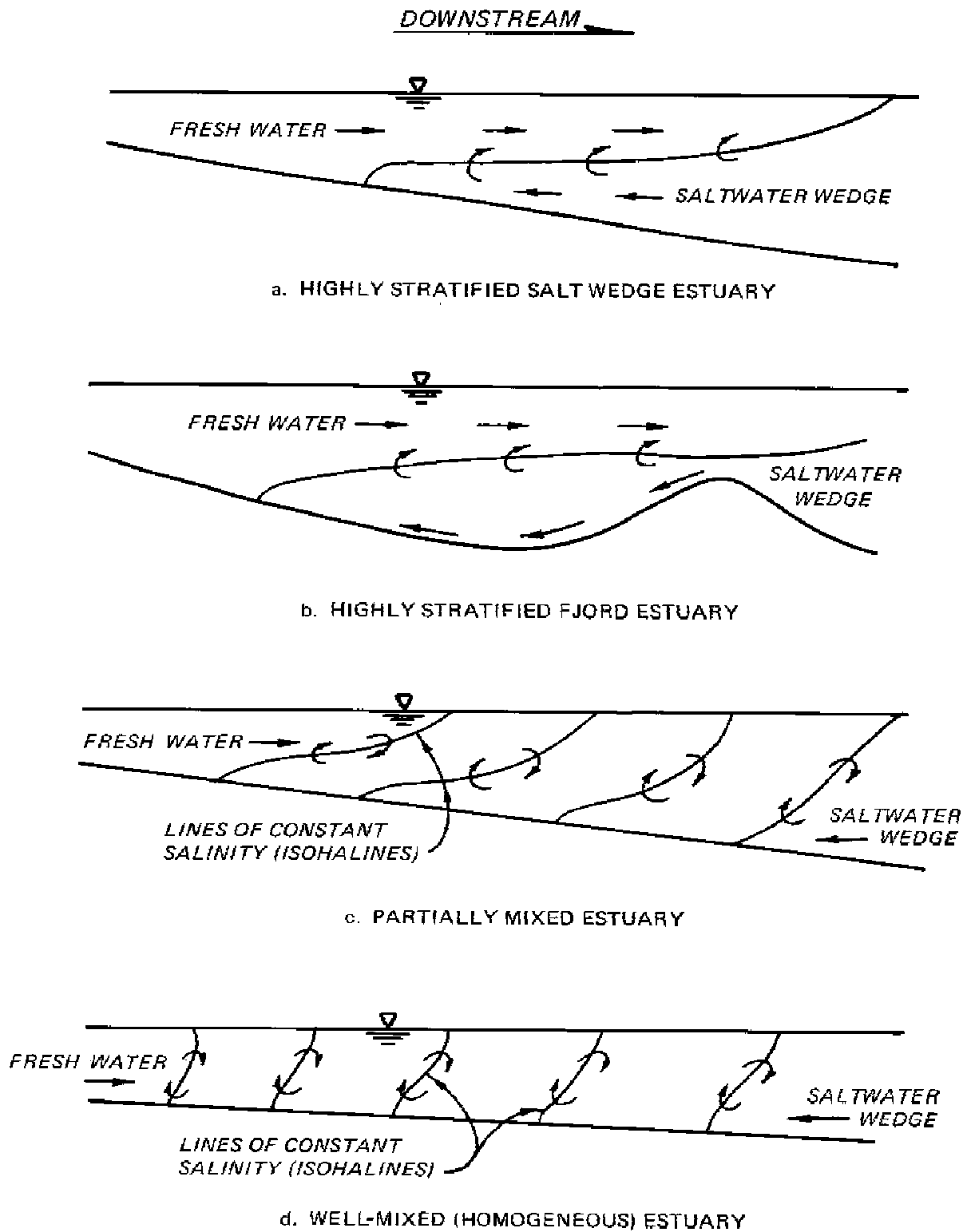

Figure 2-2. Estuary classification by salinity structure

also a longitudinal salinity gradient along the bottom (Figure 2-2c). In a partially mixed estuary, riverflow is low compared to tidal prism. Examples are James River (United States) and Mersey and Southampton Water Estuaries (England).

c. Well-mixed or Homogeneous. In estuaries where tidal flow is much larger than riverflow and bottom friction large enough to mix the entire water column, a vertically homogeneous (well-mixed) estuary results (Figure 2-2d). If the estuary is wide, Coriolis force may form a horizontal flow separation; and in the northern hemisphere, the seaward flow would occur on the right side (looking downstream), while the compensating landward flow would be on the left. This vertically homogeneous, laterally nonhomogeneous condition can be found in the lower reaches of the Delaware and Raritan Estuaries in the United States. A vertically and laterally homogeneous (sectionally homogeneous) condition occurs in narrow estuaries in which salinity increases evenly toward the mouth.

2-6. Stratification Numbers. It is clear that the different types of estuaries are not well defined but are stages on a continuum, which is controlled by the ratio of river and tidal flow. As the estuary progresses from river to ocean, it may pass through several stages of estuary types. At the head of the estuary where tidal range is reduced and riverflow is large, a highly stratified salt wedge condition may result. Farther downstream as tidal amplitudes increase, turbulent mixing occurs, and a partially mixed estuary is created. As tidal flow becomes larger than riverflow, a vertically homogeneous situation may develop. Since these stages depend on riverflow, seasonal flow changes will influence the estuary and its varying stages.

a. Simmons Ratio. Simmons (1955) related flow ratio (the ratio of riverflow per tidal cycle to the tidal prism) to estuary type. When the ratio is 1.0 or greater, the estuary is highly stratified. When the flow ratio is 0.2 to 0.5, the estuary is partially mixed, and when less than 0.1, a well-mixed condition exists. Pritchard (1955) considers estuary depth and width to be factors controlling the flow ratio. As the geometry of an estuary changes, the flow ratio is affected, and the estuary type will also vary. Constrictions cause increased current velocities and produce well-mixed sections, while wider areas tend to be more quiescent and more stratified.

b. Ippen Number. Using the tidal properties of amplitude and phase, Ippen and Harleman (1961) developed a relationship between energy and estuary mixing. This stratification number is a measure of the amount of energy lost by the tidal wave relative to that used in mixing the water column. Increasing values of the stratification number indicate increasingly well-mixed conditions, and low numbers indicate highly stratified conditions. Changes in riverflow, width, and depth will influence the tidal properties, and accurate tidal measurements are necessary to use this method.

c. Hansen Parameter. Hansen and Rattray (1966) chose the parameters of salinity and velocity to develop a means of estuary classification and comparison. Two dimensionless parameters, stratification (ratio of the surface

to bottom salinity difference divided by the mean cross-sectional salinity) and circulation (ratio of the net surface current to the mean cross-sectional velocity) are used to construct a diagram. The location on the diagram will identify the estuary stage on the continuous spectrum of estuary type. Type 1 is well-mixed (homogeneous) with net seaward flow at all depths. Type 2 experiences flow reversal and is a partially mixed estuary. Types 3 and 4 are stratified estuaries, type 3 the deep fjord type, and type 4 the intensely stratified salt wedge.

2-7. Flow Predominance. The concept of flow predominance is useful in understanding the effects of density-induced currents on velocities. In a conventional 12-hour plot of velocity versus time, velocity values will be positive (flood flow into the estuary) and negative (ebb flow out of the estuary) (Figure 2-3). To determine flow predominance, the area under the ebb portion of the curve (all negative values) is divided by the total area under the curve (ebb portion plus flood portion). The resultant, ebb predominance, is the percent of the total flow per tidal cycle that is moving in the ebb direction at a given velocity sampling depth. In a highly stratified estuary, the freshwater surface flow will always be ebb dominant, while the bottom salt wedge layer will be strongly flood dominant. Near the entrance of a well-mixed estuary, the bottom flow will be slightly flood dominant, while the surface will be strongly ebb dominant. Further upstream the flow will be ebb dominant throughout the entire depth. In a partially mixed estuary, the bottom flow will be mainly flood dominant within the salinity wedge, and the surface flow predominantly in the ebb direction. Examples of flow predominance in Savannah Harbor, Charleston Harbor, and the Hudson River are presented in "Field Experiences in Estuaries" by H. B. Simmons (Ippen 1966).

2-8. Null Point. Along with the concept of flow predominance is the realization that at some point the net flow may be balanced (no net flow in either direction). This point is called the null point.

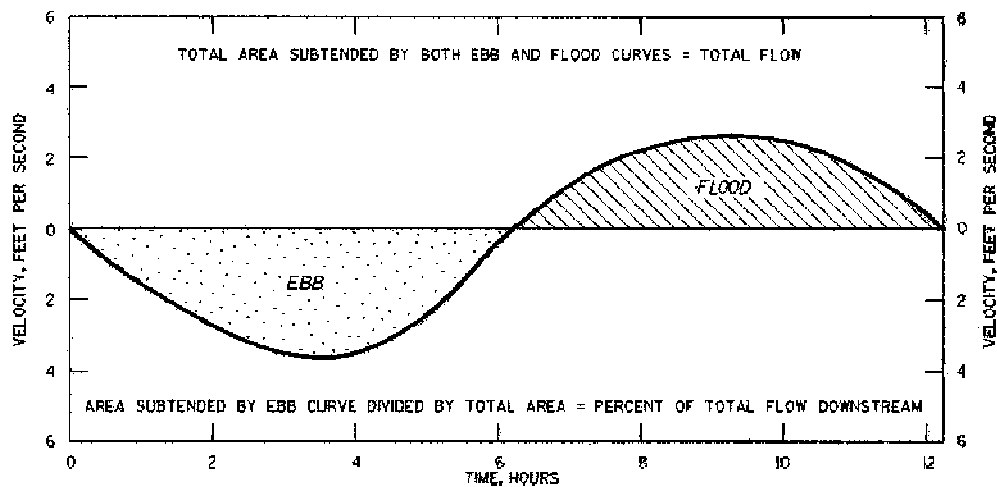

Figure 2-3. Definition sketch: flow predominance

2-9. Salinity Effects on Shoaling. Saltwater intrusion is important to estuary sedimentation because saline water enhances flocculation of suspended clay particles, and density currents tend to move sediments upstream along the bottom. Thus sediments entering the estuary may become trapped instead of moving out to sea. Frequently, shoaling occurs between the high-water and low-water positions of the upstream limit of salinity intrusion. The region most likely to experience heavy shoaling is the reach bracketing the 50 percent value (or null point) of the bottom flow predominance (Schultz and Simmons 1957) (Figure 2-4).

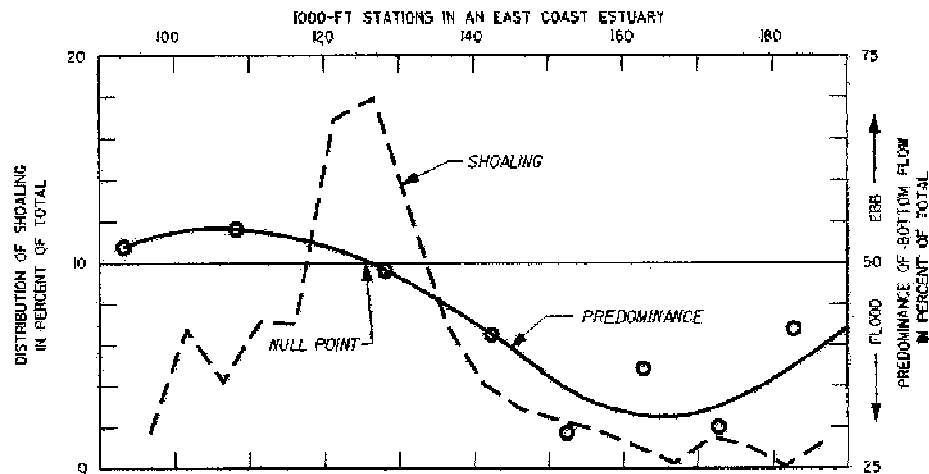

Figure 2-4. Relationship of shoaling and predominance of bottom flow

2-10. Summary. The classification of estuaries uses variables of topography, riverflow, and tidal action as factors influencing saltwater and freshwater mixing. Ultimately the salinity characteristics of an estuary determine the unique features of the system. No two estuaries are alike, but one can hope to find general principles rather than unique details to use when studying and comparing similar systems. Dyer (1973) describes in detail several estuaries with different topographies, tidal ranges, and riverflows, while Cameron and Pritchard (1963), Lauff (1967), and Ippen (1966) have tried to identify the relevant general principles governing estuarine behavior.

### Section III. Tides and Other Long Waves

2-11. Tide-Generating Forces. To understand the effect of tides on an estuarine system, a brief comment should be made on the tidal-generating forces and rhythms.

a. Newton's laws of gravitation state that the force of attraction between two bodies is proportional to the product of their masses and inversely proportional to the square of the distance between their centers.



15 Mar 91

Tidal forces, acting on the surface of the earth, are less than gravitational forces and vary inversely with the cube of the distance between bodies. In our sun-moon-earth system, the sun is the largest body, but because its distance is so great from the earth, its influence on tides is only 46 percent of the moon's.

b. All forces in the sun-moon-earth system are in equilibrium; however, individual particles on the earth's surface are not. In this system of varying distances from each other and different rotation rhythms (the earth once every 24 hours and the moon around the earth once every 24 hours and 50 minutes), these tide-generating forces are never constant. These forces act on land, water, and air. However, the land mass is not as elastic as liquids, and air, although elastic, has such a low density that the effects of the tidal forces, although measurable, are small. The media most free to respond in an observable manner are the earth's water masses, the oceans. Tide-generating forces are the residual forces between attraction (earth/moon and earth/sun) and centrifugal force (due to the rotation of two bodies about a common axis). A detailed description of tidal theories can be found in Darwin (1962) and Defant (1958), and in a more readable form in Wylie (1979) and Marmer (1926).

2-12. Tide Terms. Several basic terms are used to describe tides. High water is the water-surface level at its highest extent during one cycle and is also used to denote the time at which it occurs. Low water is used in the same way for the lowest water level. Where there are two unequal high waters and two unequal low waters in one day, they are distinguished by naming them higher high water, lower high water, lower low water, and higher low water. A tidal current that is flowing landward is termed a flood current, while one flowing seaward is called an ebb current.

2-13. Types of Basic Tides. The basic tide is the cyclic rise and fall of the water surface as the result of the tide-generating forces. There are three types of tides--diurnal, semidiurnal, and mixed--which are a result of tide-generating forces and location on the earth.

a. Diurnal. A diurnal tide is one high and one low water level in a lunar day (24.84 hours). Diurnal tides predominate in the Gulf of Mexico, some parts of the Pacific Ocean, e.g., the Philippines, and certain places in Alaska.

b. Semidiurnal. Semidiurnal tides produce a tidal cycle (high and low water) in one-half the lunar day (12.42 hours) or two nearly equal tidal cycles in one lunar day. Semidiurnal tides occur along the east coast of the United States.

c. Mixed. Mixed tides are a combination of diurnal and semidiurnal characteristics and are found on the west coast of the United States. There is a marked inequality in the heights of the succeeding tides, especially low waters, and there is also an inequality in time. There are usually two high and two low waters each day. Typically, there is a high tide, then a low

tide, followed by a scanty high tide and a moderate low tide.

2-14. Spring and Neap Tides. Due to the unequal rotational rhythms of the members of the sun-moon-earth system, their forces are periodically in and out of phase. Every 14.3 days (twice a month) the earth, moon, and sun are aligned in phase. At this time the gravitational forces reinforce each other to form higher than average tides called "spring tides." Also twice a month the moon and sun are at right angles to the earth and the forces are subtracted from each other to form lower than normal tides called "neap tides."

2-15. Influence of Moon and Sun. Another factor influencing the tide is the declination of the moon and sun--their angular distance north or south of the equator. The relationship of the earth's axis to the plane of its orbit around the sun results in an apparent yearly north-south movement of the sun. The plane of the moon's orbit is tilted also, and the apparent north-south migration across the equator occurs every 27-1/3 days. This monthly migration results in observable tidal changes. Figure 2-5 illustrates the differences in tides at various places for a month. During this month, spring tides (new and full moon) happen to occur when the moon is crossing the equator. Neap tides occur at the quarter moon, and apogee (moon furthest from the earth) and perigee (moon closest to the earth) effects are noted. The spring tide occurring at perigee is larger because of the increase in tidal forces. The tides at New York are semidiurnal with a strong spring and neap influence. Tides at Port Adelaide, Australia, go from mixed to semidiurnal when the moon is over the equator, while tides at Seattle, Washington, are mixed at all times. Tides at Los Angeles, California, and Honolulu, Hawaii, are diurnal during neap tide when the moon is south of the equator, semidiurnal during spring tide, and mixed at other times of the month. Tides at Pakhoi, China, are strongly diurnal except when the moon is over the equator.

2-16. Tide Prediction Tables. The National Oceanic and Atmospheric Administration (NOAA) annually publishes "Tide Tables, High and Low Water Predictions" (NOAA, year of interest). The four volumes include the entire maritime world and contain daily tide predictions for 198 reference ports and tidal differences and other constraints for about 6,000 subordinate stations. Each volume, which covers a different section of the world, contains tables for obtaining the approximate height of the tide at any time; local mean time of sunrise and sunset for every fifth day of the year for different latitudes; the reduction of local mean time to standard time; moonrise and moonset for a number of locations; the Greenwich mean time of the moon's phase, apogee, perigee, greatest north and south zero declination, and the time of the solar equinoxes and solstices; and a glossary of terms.

2-17. Tidal Constituents. The tide-producing forces exerted by the moon, sun, and other astronomical bodies are represented by mathematical expressions. There are over 128 tidal constituents used to represent the various wavelengths and frequencies found in nature (Schureman 1940).

2-18. Nonastronomical Forces. Nonastronomical forces can also produce waves. A tsunami, or seismic sea wave, is a very long wave originating from a

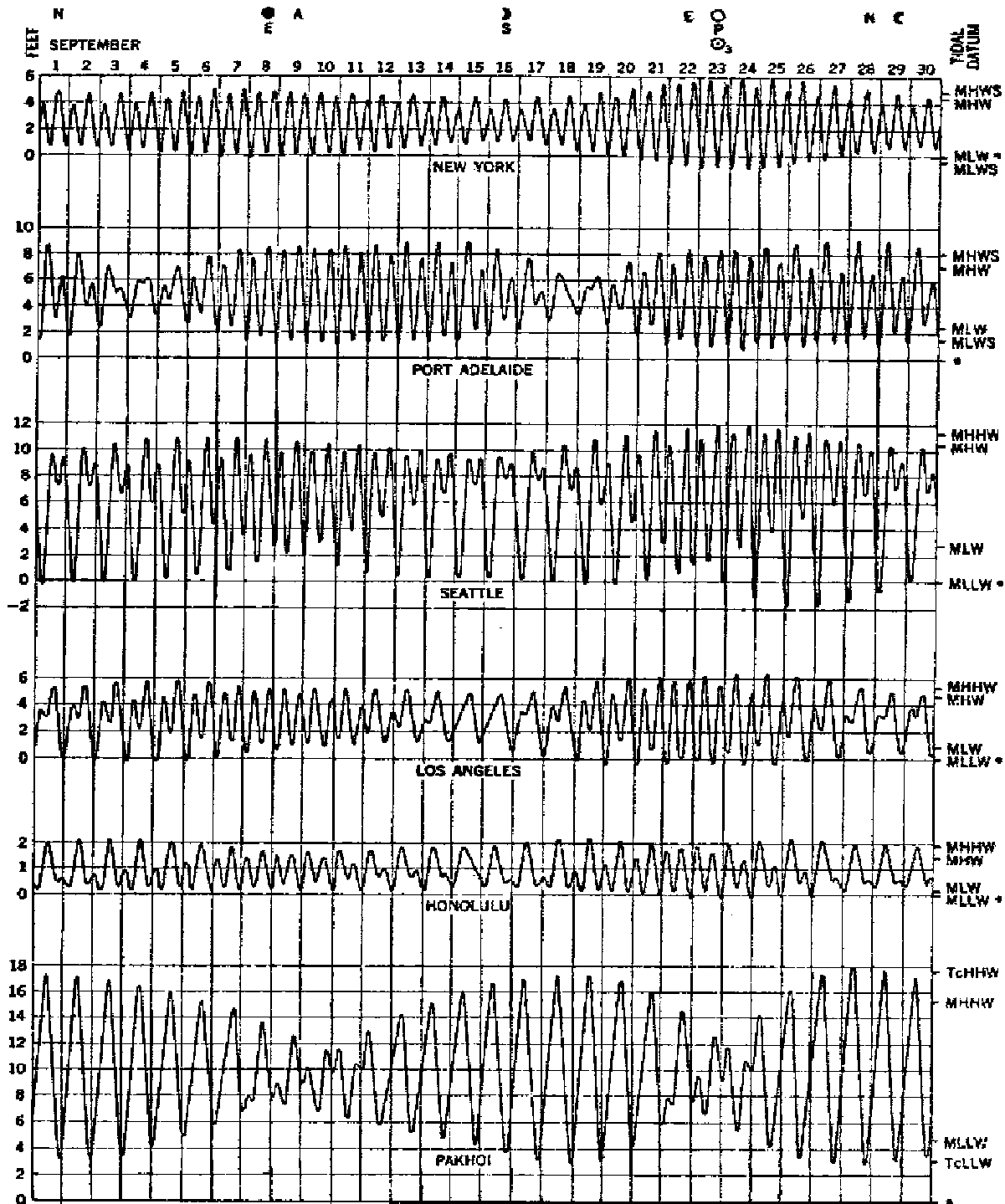

●, new moon; ☾, first quarter; ○, full moon; ☾, last quarter; E, moon on the Equator; N, S, moon farthest north or south of the Equator; A, P, moon in apogee or perigee; ☉, sun at autumnal equinox.  
 • chart datum.

Figure 2-5. Variations in tides by location

disturbance in the seafloor. The wave train generated from such an event (earthquake, mud slide, volcanic explosion) contains huge amounts of energy and moves at high speeds. When it reaches shallow water and the shoreline, it can be extremely destructive. Other nonastronomical waves are produced by boat wakes, explosions, landslides, and any force that can disturb the surface of the water.

2-19. Waveforms. The tide may enter the estuary as a progressive wave manifested by the forward movement of the waveform. The current velocity and water-surface elevations in this waveform are in phase. As the wave progresses up the estuary, the waveform changes shape, the face steepening and the rear slope becoming more gradual. Areas of constriction increase the wave amplitude, and boundary friction is a means of energy dissipation. At some point in time, as the wave reaches the end of the estuary, it may be reflected and the interaction of the forward-advancing progressive wave and the returning reflected wave may produce a standing wave. In a standing or stationary wave, the current velocity and water-surface elevation are out of phase by 90 degrees. Most estuaries are intermediate, displaying characteristics somewhere between progressive and standing wave features.

#### Section IV. Winds and Wind-Generated Waves

2-20. General. Meteorological factors such as changes in barometric pressure and the uneven heating and cooling of the earth produce pressure differences that result in winds. Winds blowing across the surface of bodies of water transmit energy to the water, and waves are formed. The size of these wind-generated waves depends on the wind velocity, the length of time the wind is blowing, and the extent of open water over which it blows (fetch).

2-21. Wind Effects. The water surface absorbs energy from the wind and from smaller waves to form higher, longer waves. At any point in time, the resultant waves are the summation of all the waves passing through a given location. The concept of wavelength and period no longer applies in such an unsteady environment. Instead, a method of describing waves by means of their energy spectra is used. Tables have been developed relating wind description and its observed effects on the water surface to a classification system such as the Beaufort Scale and the International Code for state of the sea. Examples of these and information on other topics in this section can be found in many publications such as Bascom (1980).

2-22. Setup and Setdown. In addition to the creation of wind waves, wind can also cause a condition known as "setup" or "setdown." Wind stress on the water surface can result in a pushing or piling up of water in the downwind direction and a lowering of the water surface in the upwind direction. When the wind blows landward, water will set up against the land. This setup, superimposed on the normal tidal elevation, causes apparent higher than normal tides. This frequently produces flooding during storm events. A seaward wind will push water toward the sea and away from land, causing a lower than normal water level. When the wind stops, the setup or setdown water surface will return to normal levels. In enclosed waters, this return may occur as

successive oscillations that are diminished by friction.

2-23. Seiche. If the surface of an enclosed body of water such as a harbor or bay is disturbed, long waves may be generated that will rhythmically slosh back and forth as they reflect off the opposite ends of the basin. These waves, called seiches, will travel back and forth until the energy is lost to frictional forces. The period of a seiche is dependent upon the size and depth of the basin in which it occurs. If an arriving wave train has a period similar to the natural frequency of a harbor, each arriving wave will increase the intensity of the seiche, producing rougher waters inside the harbor than on the surrounding sea.

2-24. Storm Surge. During a storm, there may be a substantial rise in the sea level along the coast called a "storm tide" or surge caused by wind setup, wave setup, and air pressure drop. The difference in pressure between an atmospheric low-pressure area and the surrounding high-pressure area causes the sea surface to "hump" under the influence of lower atmospheric pressure. The wind-generated storm waves superimposed on the normal tides and storm surge can have disastrous effects on shore structures and produce flooding of the coastal and inland areas.

#### Section V. Freshwater Inflow

2-25. Freshwater Sources. So far the topographic classification of estuaries, the astronomical tide-generating factors, and the meteorological and seismic wave-generating factors have been discussed. The final critical forcing function of an estuary is the amount of fresh water delivered to the system. This fresh water can be flow from the drainage basin of the river, ground water, discharge from dams and reservoirs, and rain falling on the water surface. The US Geological Survey (USGS), Water Resources Division, in cooperation with state and local governments, collects and disseminates hydrologic data of stream discharge or stage, reservoir and lake storage, ground-water levels, and the quality of surface and ground water. All data are stored in the USGS National Water Storage and Retrieval System (WATSTORE) and are available upon request to the USGS regional office or the USGS in Reston, Virginia.

2-26. Episodic Events. Episodic events that produce extreme quantities of water in a drainage basin can have a significant effect on the freshwater/salinity balance of an estuary. The seaward displacement of the salinity zone by sediment-laden fresh water will result in drastically different salinity and shoaling patterns.

#### Section VI. Changes in Sea Level

2-27. Sea Level Rise. Sea level rise refers to the rise in sea level or the apparent rise in the ocean surface when compared to a stable landmark. This, however, is a very general description for a more complicated event. The actual rise in the ocean is not one that is readily noticeable, especially when the average value varies 0 to +1 centimetre per year. The geologic

record indicates that shifts in climate and the associated changes in sea level are attributed to the global freeze and thaw cycles. These trends are most noted in the Pleistocene Epoch, or ice age, when the ocean level was much lower due to the fact that much of the available water was frozen in the glaciers. Other events and factors can affect the rate of change:

a. The Greenhouse Effect. Overall global warming (postulated by the greenhouse effect) will cause thermal expansion of the seas and melting of snow and ice at increased rates and thus increase ocean levels. The greenhouse effect is not a part of the cyclic warming or cooling periods of natural weather patterns, but is related to man-influenced changes in the atmosphere and ozone layer. Future rates of change caused by warming are unknown.

b. Subsidence. Along coasts consisting of deposited materials, subsidence may occur due in part to consolidation of recent sediments. Subsidence may also occur due to man's activities, such as withdrawal of oil, natural gas, and water, or by the additional weight of structures.

c. Tectonic Activity. Such events as earthquakes and crustal movements may in fact raise or lower coastal areas somewhat and as a result negate or magnify the rising sea level.

d. Geomorphology of the Area. Some coastlines are termed as sinking (such as the US east coast) whereas some are considered rising (US west coast). Few, if any, reliable measurements are available.

2-28. Apparent Sea Level Rise. Because of these and other factors, it would be more accurate to use the term apparent sea level rise since there is the possibility that the particular area in question may actually be subsiding. Additional reading on this topic can be found in most books dealing with oceanography, geology, and geomorphology.

## Section VII. Summary

2-29. Classifying an Estuary. The classic definition of an estuary includes these three characteristics: semienclosed, free connection with the open sea, and fresh water derived from land drainage. These three characteristics govern the concentration of seawater; therefore, salinity is the key to estuarine classification. The mixing of fresh water and seawater produces density gradients that drive distinctive estuarine (gravitational) circulation patterns. These circulation and shoaling patterns differ with each estuary system according to the depth, tidal amplitude and phase at the mouth, and the amount of fresh water flowing into the basin. The tide that approaches the mouth of the estuary is the result of all the astronomical, meteorological, seismic, and man-made factors affecting amplitude and frequency of the wave. As the tide enters the estuary, it is greatly influenced by the river depth, width, and discharge. Tides exhibit wave behavior, usually as a combination of progressive and standing waves, with maximum flood velocity occurring 1-3 hours after high water. Superimposed on this tidal action is the freshwater/saltwater interaction. Salt water will advance up a system until the tidal

EM 1110-2-1607  
15 Mar 91

flow can no longer overcome the riverflow. Depending on the relationship between tidal flow and riverflow, the estuary can be classified by its salinity structure and resulting circulation patterns.

CHAPTER 3

HYDRODYNAMIC ANALYSIS OF ESTUARIES

Section I. Factors Influencing Hydrodynamics

3-1. Introduction. A hydrodynamic analysis of a complex estuarine system requires a reasonable knowledge of those factors influencing estuarine circulation. Circulation in estuaries is quite complex and mainly dependent on the relative magnitudes of tidal variations in water levels and currents, freshwater inflow, gravitational forces caused by density differences between the ocean and fresh water, and to a lesser extent, the Coriolis acceleration. Wind and waves also become important for some estuaries and for short durations in most estuaries. The mixing regime and resultant salinity distribution depend on the relative magnitudes of these forces.

3-2. Tides. See Paragraphs 2-11 through 2-19.

3-3. Freshwater Inflow. See Paragraphs 2-25 and 2-26.

3-4. Salinity. See Paragraphs 2-5 through 2-9.

3-5. Coriolis Force. In large estuaries the earth's rotation deflects flowing water to the right in the northern hemisphere and to the left in the southern hemisphere. In the northern hemisphere, flood tide currents are deflected towards the left (looking seaward) and ebb current to the right, resulting in a net counterclockwise circulation. This circulation is referred to as Coriolis circulation. Therefore, water-surface elevations are higher on the left (looking seaward) during flood tide and higher on the right during ebb tide. Coriolis force explains why in Chesapeake Bay the salinity is, on the average, higher on the eastern shore (on the left looking seaward) than on the western shore. A detailed discussion on Coriolis is given by Officer (1976).

3-6. Geometric Influences. The amplitude of a tidal wave progressing up an estuary is influenced by the geometry of the estuary in several ways:

a. If the estuary is convergent, the amplitude tends to increase.

b. Since the length of the estuary is generally less than the tidal wavelength, wave reflection from the sidewalls may be expected due to rapid convergence. This continuous reflection of energy tends to reduce the incident wave amplitude.

c. Energy dissipation by boundary friction tends to reduce the amplitude of the incident wave. If the estuary has a small bottom slope and is very long and without physical obstructions, the latter two effects may dominate and the tidal amplitude may gradually diminish to zero. The motion in such an estuary is therefore characterized by a single progressive wave. In such case the incident wave at the ocean entrance is equal to that which



would be observed by a tide gage at that point.

3-7. Seiching. Seiches are standing waves of relative long periods that occur in basins. Seiches in basins within estuaries can be generated by local changes in atmospheric pressure and wind and by oscillations transmitted into an estuary from the open sea. Standing waves of large amplitude are likely to be generated if the force that sets the water basin in motion is periodic in character, especially if the period of the force is the same as, or is in resonance with, the natural free oscillating period of the basin. Equations that can be used to evaluate basins with regard to seiching problems have been developed (Abbot 1979 and Silvester 1974).

3-8. Temperature. The density of seawater depends on both the salinity and temperature, but in estuaries the salinity range is large and the temperature range is generally small. Consequently, temperature has a relatively small influence on the density. Little information has been published on temperature fluctuations in estuaries. One can visualize estuaries, however, where temperature could be a dominant factor at times. Many tropical estuaries have little riverflow entering them during the hot season. Surface heating could then provide sufficient density difference between the estuary and the sea to maintain a gravitational circulation; however, these effects would be transitory. In many fjords there is no river discharge in winter and surface waters can then become more dense than those at depth and will tend to sink. This vertical circulation phenomenon is known as thermocline convection.

## Section II. Solution Methods

3-9. General. Solutions to estuarine hydrodynamic problems are obtained principally by use of the four primary methods--field observations, analytical solutions, numerical models, and physical models. Any of these four, or a combination thereof, may be the best approach for solving a particular problem. Choosing between them requires knowledge of the phenomena that are important to the problem and an understanding of the strengths and weaknesses of the solution methods (McAnally et al. 1983).

3-10. Field Observations. Field (prototype) data collection and analysis serve both as an important aspect of the other solution methods and as an independent method. Alone, field data demonstrate the estuary's behavior under the specific set of conditions that existed during the time of measurement. By skillful scheduling of data collection, careful analysis, and luck, one can obtain estimates of the separate effects of tides, river discharge, wind, and other variables. Field data can reveal problem areas, define the magnitude of problems, and can, to a limited extent, be used to estimate the estuary's response to different conditions of tide and river discharge. They can also be used in an attempt to identify changes caused by a modification to the estuary. Field data are also an indispensable element in verification of numerical and physical models; they are used by the modeler to adjust the model and show that model results are reliable. Obtaining sufficient temporal and spatial data coverage in the field is a formidable and expensive task; available field data are often too sparse to describe an estuary in any but

the most general terms. Those not intimately familiar with data collection and analysis often overestimate the accuracy and reliability of the data. Information on the design of a field survey along with an example is given in Appendix B.

3-11. Analytical Solution Methods. Analytical solutions are recognized as a separate solution method, but they must be carefully defined to distinguish them from numerical models. Analytical solutions are those in which answers are obtained by use of mathematical expressions. These expressions or equations describe physical phenomena in mathematical terms and thus may be considered to be mathematical models of physical reality. For example, Manning's equation is a simple analytical model of the complex process of energy losses in open-channel flows. A more rigorous and complete analytical model of the losses is included in the turbulent version of the Navier-Stokes equations, known as the Reynolds equations.

a. Analytical models usually combine complex, poorly understood phenomena into coefficients that are determined empirically. Manning's roughness coefficient, for instance, combines the various effects of energy dissipation into a single parameter. The degree of simplification of the analytical model dictates how it is solved. For example, Manning's equation can be solved directly, whereas the Reynolds equations must be simplified and solved by numerical methods.

b. If an analytical model can be solved by substituting values of the independent variables into the equation (a closed form solution), then the solution method is also analytical. The calculation may be performed by hand or by a computer, but the solution is still an analytical one.

c. The analytical solution method has advantages of speed and simplicity but it cannot provide many details. In estuaries, analytical solutions can be used for gross representations of tidal propagation and average cross-sectional velocities in simple geometries. Details of flow cannot be predicted. The usefulness of analytical solutions declines with increasing complexity of geometry or increasing detail of results desired.

d. As an example, an analytical solution technique for the prediction of salinity intrusion in an estuary is given in Appendix C.

3-12. Numerical Modeling. Numerical modeling employs special computational methods, such as iteration and approximation, to solve mathematical expressions that do not have closed form solutions. A numerical model thus applies numerical (computational) analysis to solve mathematical expressions that describe the physical phenomena. The distinction between analytical solutions obtained by computer calculations and numerical modeling solutions may become blurred, but the distinction is a valid one that should be maintained. In this EM, the computer programs used to solve the governing equations are referred to as generalized computer programs or codes. When the codes are combined with a geometric mesh (grid) and specified parameters representing a particular estuary, the combination is called a model.

a. Numerical models used in coastal hydraulic problems are of two principal types--finite difference and finite element. The finite difference method (FDM) approximates derivatives by differences in the value of variables over finite intervals of space and time. This requires discretization of space and time into regular grids of computation points. Finite difference methods have been in widespread use for unsteady flow problems since 1970, whereas the finite element method (FEM) has been widely applied to open-channel flow problems only since 1975. The latter method employs piecewise approximations of mathematical expressions over a number of discrete elements. The assemblage of piecewise approximations is solved as a set of simultaneous equations to provide answers at points in space (nodes) and time.

b. Numerical models are classified by the number of spatial dimensions over which variables are permitted to change. Thus in a one-dimensional flow model, currents are averaged over two dimensions (usually width and depth) and vary only in one direction (usually longitudinally). Two-dimensional models average variables over one spatial dimension, either over depth (a horizontal model) or width (a vertical model). Three-dimensional models solve equations accounting for variation of the variables in all three spatial dimensions.

c. Numerical modeling provides much more detailed results than analytical methods and may be substantially more accurate, but it does so at the expense of time and money. Models of sufficient detail may require very large computers to solve the large systems of equations and store results. Once a numerical model has been formulated and verified for a given area, it can quickly provide results for different conditions. Numerical models are capable of simulating some processes that cannot be handled in any other way. However, they are limited by the modeler's ability to provide and accurately solve mathematical expressions that truly represent the physical processes being modeled. For example, existing three-dimensional models are presently considered to be the most effective method for predicting wind-induced currents in complex geometry, but physical models are considered superior for salinity-induced density current prediction in complex geometries. Because of their newness, much less is known about the ability of numerical three-dimensional models to reproduce estuarine flows. An example two-dimensional numerical model investigation is given in Appendix C.

3-13. Physical Models. Physical scale models have been used for the past century to solve estuarine hydraulic problems. Careful observance of appropriate scaling requirements permits the physical modeler to obtain reliable solutions to problems that often can be solved no other way. Physical hydraulic models of estuaries can reproduce tides and other long waves, some aspects of short-period wind waves, longshore currents, freshwater flows, pollutant discharges, some aspects of sedimentation, and three-dimensional variations in currents, salinity, density, and pollutant concentration. Applicability of model laws and choice of model scales are dependent on which of these phenomena are of interest. Present practice does not include simulation of water-surface setup and currents due to wind. Conflicts in similitude requirements for the various phenomena usually force the modeler to neglect similitude of some phenomena to reproduce more accurately the dominant processes of the

situation. For example, correct modeling of tides and currents often requires that a model have different scales for vertical and horizontal lengths. This geometric distortion permits accurate reproduction of estuarine flows and is a common and acceptable practice, but it does not permit optimum modeling of short-period waves, which requires an undistorted-scale model for simultaneous reproduction of refraction and diffraction.

3-14. Hybrid Method. The preceding paragraphs have described the four principal solution methods and some of their advantages and disadvantages. In practice, two or more methods are used jointly, with each method being applied to that portion of the problem for which it is best suited. For example, field data are usually used to define the most important processes and verify a model that predicts hydrodynamic conditions in an estuary. Combining two or more methods in simple ways has been common practice for many years. Combining physical modeling and numerical modeling to provide results not obtainable any other way is termed a hybrid solution method; combining them in a closely coupled fashion that permits feedback between the models is termed an integrated hybrid solution. Judicious selection of solution methods in a hybrid approach can greatly improve accuracy and detail of the results. By devising means to combine results from several methods, the modeler can include effects of many phenomena that previously were neglected or poorly modeled. Examples of processes that are good candidates for hybrid modeling are sediment transport and flow hydrodynamics or tidal flows and short-period waves. In the first case, hydrodynamics drives the sediment transport process, and if the study is carefully designed, the feedback from bed change to hydrodynamics is minimal. In the second case, the interaction of the two processes is often dominated by one or the other such that they can be analyzed as independent events and the results combined. Processes that have a strong feedback loop, such as the hydrodynamics of freshwater/saltwater interaction, are not suitable for the hybrid approach and consequently should be analyzed together.

## CHAPTER 4

### SEDIMENTATION ANALYSIS OF ESTUARIES

4-1. Introduction. This chapter will provide an overview of the various concepts of sedimentation in estuaries, the processes and transport, and the analysis and modeling methods currently in use. For those readers of this manual who are concerned directly with problems of estuarine sedimentation, a more complete treatment of this subject, including notation, is presented in Appendix D.

4-2. Sediment Sources. Identification of the sources of sediment can be a key factor in problem solving.

a. Upland. The predominant source usually is erosion of lands bordering the water body, but erosion of banks by currents and waves within the estuary itself, as well as aeolian transport, introduces smaller amounts of sediment more directly. Municipal, agricultural, and industrial wastes may also be a significant source of sediments.

b. Biogenic. In biologically active areas, production within marshes and the main estuarial water body itself can significantly enhance suspended sediment load (Kranck 1979).

c. Coastal. Close to the estuarial mouth, the sediment is often of marine origin. In areas where the open seacoasts are sandy, such as along much of coastal Florida, it is common to find the bed in the mouth or entrance channel to consist predominantly of sand. Landward of the entrance the grain size decreases and the fraction of fine-grained material of marshy origin tends to increase with distance upstream (Mehta and Jones 1977). In some estuaries, e.g., the Mississippi or the Amazon, where sediment supply from upstream sources has been relatively high on a geologic time scale, the offshore ebb delta is laden with deep layers of fine-grained material (Gibbs 1977; Wells 1983). Salinity- and tide-driven flows can transport some of the ebb deltaic deposits (resuspended during flood flows coupled, oftentimes, with offshore wave activity) upstream through the channel. The material is then redeposited in reaches where the currents are too weak to transport the material further (Partheniades 1966).

4-3. Sediment Classification. For engineering purposes, sediments are customarily classified primarily according to particle size. Sediment of size greater than about 0.074 mm (No. 200 sieve size) is considered to be coarse, and less than this size, fine-grained. The boundary between cohesive and cohesionless sediment is, unfortunately, not clearly defined and generally varies with the type of material. It is, however, appropriate to state that cohesion increases with decreasing particle size. Clays (particle size < 0.005 mm) are much more cohesive than silts (0.005 to 0.074 mm), and, in fact, cohesion in natural muds is due primarily to the presence of clay-sized sediment.

a. Muds. Estuarial muds are typically composed of a wide range of materials including clay and nonclay minerals in the clay- and silt-size ranges, organic matter, and sometimes small quantities, e.g., ~5-10 percent by weight, of very fine sand.

b. Size. The particle size distribution of cohesionless materials is easily determined by sieve analysis, and reported in terms of either diameter  $d$  or in  $\phi$  units (i.e., as  $-\log_2 \times \text{diameter, mm}$ ) (Vanoni 1975).

c. Settling Velocity. The key transport-related parameter of sediments is the settling velocity, which, unfortunately, does not bear a unique relationship to particle size. Laboratory settling columns can be used to measure settling velocity distribution, which may be considered as a very useful property for sediment classification (Channon 1971; Vanoni 1975).

d. Cohesive Treatment. Standard hydrometer or pipette methods are used to determine the dispersed particle size distribution (American Society for Testing and Materials (ASTM) 1964). The original sample should not be dried before determining the size distribution, inasmuch as prior drying prevents the material from dispersing adequately (Krone 1962).

e. Deflocculation. Cohesive sediment size distribution obtained without dispersion will be that of the flocculated material.

f. Settling Tests. A convenient laboratory procedure for obtaining the settling velocity of flocculated sediment consists of settling tests in a column from which suspended sediment can be withdrawn at various elevations and different times after test initiation (Owen 1976; Vanoni 1975).

4-4. Coarse Sediment Transport. Coarse-grained sediment includes material with particle sizes larger than about 0.074 mm (74  $\mu\text{m}$ ), the most common sediment being sand, although some estuarial beds are laden wholly with coarser material including shells and gravel (Kirby 1969).

a. Tidal Entrance. With reference to sand transport, the estuarial mouth or tidal entrance can be conveniently treated as a geomorphologic unit separate from the remainder of the estuary.

b. Formula Application. The application of sediment transport formulas developed for unidirectional flows is usually suitable to tide-dominated oscillatory flows because the tidal frequency is low, and tidal currents may be considered to be "piecewise" steady. Differences tend to arise due mainly to three causes:

(1) The complexity of flow distribution resulting from salinity effects.

(2) The condition of slack water and flow reversal following slack.

(3) The dependence of bed forms and associated bed resistance on the stage of tide and the direction of flow (Ippen 1966).

c. Rate of Transport. The total rate of sediment transport is the sum of contributions from bed load and suspended load. A dependence of bed-load rate on flow velocity cubed is consistent with the concept of relating sediment transport to unit stream power (Yang 1972; Vanoni 1975).

d. Total Load. Bed material load is that portion of the total load represented in the bed. The remainder is wash load. As is evident, this material is typically fine-grained and, unlike bed material load, it is believed to be independent (uncorrelated) of flow condition (Partheniades 1977).

e. Sediment Behavior. Whether a sediment under a given flow condition behaves as bed load or as suspended load depends on the relationship between the entrainment function and the dimensionless grain size as illustrated in Figure 4-1 (Ackers 1972).

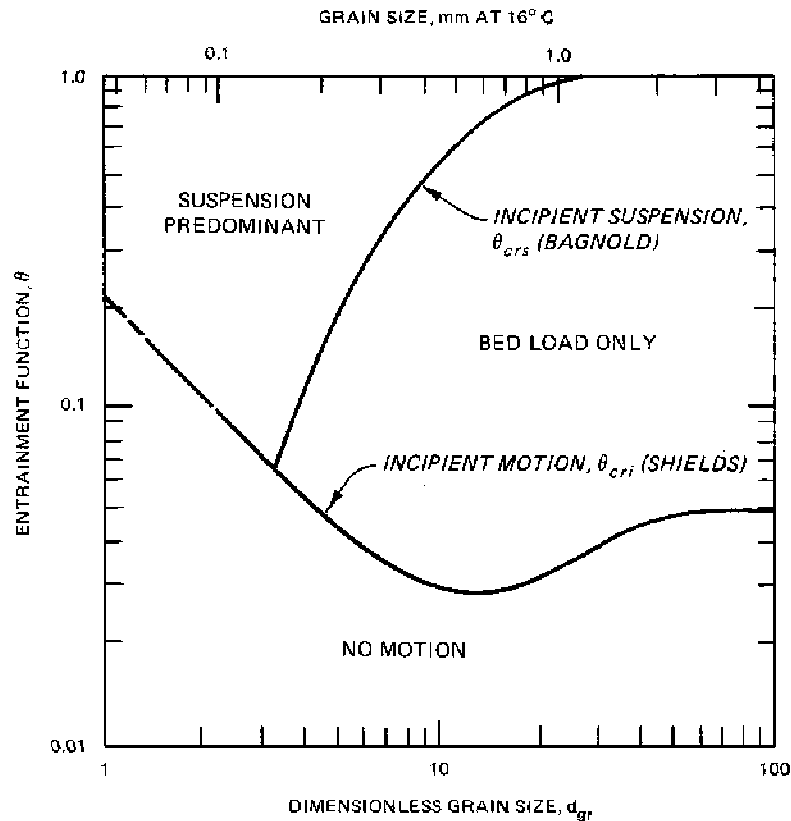

Figure 4-1. Relationship between entrainment function  $\Theta$  and dimensionless grain size  $d_{gr}$  (after Ackers 1972)

f. Contribution by Load. The contribution of suspended load relative to bed load (in total load) depends on the grain size, the flow regime, and the estuarial morphology.

g. Sediment Supply. The rate of supply of "new" sediment from the river varies widely from one estuary to another, and, in a given estuary, there is usually a strong seasonal dependence as well (Krone 1979). Normally, however, the oscillatory, "to and fro," tide-controlled transport is orders of magnitude higher than the net (incoming minus outgoing) input of sediment. In the long term, such factors as changes in the upstream discharge hydrograph and sediment supply rates, morphologic changes within the estuary, sea level change, and eustatic effects will alter the sediment transport regime (Dyer 1973; McDowell and O'Connor 1977).

h. Closure. Closure or tidal choking is a potential problem at sandy entrances in which the strength of flow is insufficient to scour the bed, with the result that littoral drift is deposited in the mouth, the depths become shallow, and the entrance closes eventually (Bruun 1978). Training walls or jetties and dredging between the jetties coupled, sometimes, with a system for bypassing sand from the updrift beach to the downdrift beach can be used to keep entrances open (Bruun 1978).

4-5. Cohesive Sediment Transport. Cohesion results from interparticle electrochemical forces, which become increasingly important relative to the gravitational force with decreasing particle size below ~0.04 mm. Clays, which have sizes less than 0.005 mm, are particularly cohesive (van Olphen 1963). In addition to the negative charge on its surface, the clay particle, like all material surfaces, possesses London-van der Waals electrochemical forces of atomic origin. If sufficient salt is present, the double layer is considerably compressed and the London-van der Waals forces "stick out" beyond the double layer. In this event, the micelles will attract each other and coagulation will occur.

a. Particle Cohesion. Particle cohesion requires interparticle collision. There are three basic mechanisms for collision: Brownian motion, flow shear due to turbulence, and settling of particles at different speeds, or differential settling (Hunt 1980). Out of these, shearing in the fluid column, which is prevalent throughout the tidal cycle except at slack water, produces the strongest interparticle bonds (Krone 1972).

b. Salinity Effects. When salt concentration in water exceeds 2 to 3 ppt, coagulation of major clay types, i.e., kaolinite, illite, and montmorillonite, is complete (Hayter 1983).

c. Settling Velocity. Under continued collision, aggregates tend to build up into units of different densities, shear strengths, and sizes, and these consequently have different settling velocities. Each sediment-fluid mixture has its own characteristic settling velocity-concentration relationship (Krone 1962; Burt and Stevenson 1983).



d. Concentration Effects. At very low concentrations, e.g., ~100 mg/l or less, interparticle collision frequency is restricted and the settling velocity shows no significant dependence on concentration. At higher concentrations, up to ~3,000-5,000 mg/l, aggregation is enhanced with increasing concentration. At even higher concentrations the settling velocity begins to decrease with increasing concentration. This is referred to as hindered or zone settling. The term fluid mud is often used to describe a high concentration (> 10,000 mg/l) suspension that characteristically exhibits the hindered settling behavior (Krone 1962).

e. Exceptions. Aggregates of sediment in the clay- and silt-size range typically behave as bed material load (however, not as bed load), while very fine material, e.g., derived from biogenic sources, often behaves as wash load, not being represented in the bed.

f. Particle Size. Inasmuch as cohesive aggregate properties (e.g., size, density, and shear strength) depend on the type of sediment-fluid mixture as well as on the flow condition itself, particle size has a different meaning here than in the case of cohesionless sediment, since aggregate size is not an easily characterized quantity. Critical shear stress for erosion depends on the mode of formation and degree of consolidation of the bed (Mehta et al. 1982). It becomes essential to conduct laboratory erosion tests to evaluate the bed shear strength for a given mud-fluid mixture (Mehta et al. 1982; Parchure 1984).

g. Deposition. The processes of cohesive sediment deposition and erosion are interlinked through bed consolidation. Rates of deposition and erosion in turn determine the rate of horizontal transport in suspension. In a tidal estuary, these processes are characteristically cyclic in nature; their interrelationship is schematized in Figure 4-2 (Mehta et al. 1982). As observed, suspension in horizontal transport interacts with the bed through tide-controlled, time-dependent, deposition-consolidation-erosion process. During consolidation (and gelling), upward escape of the pore water occurs, the bed density increases, and physicochemical changes occur within the bed as the deposited aggregates are crushed slowly under overburden. A settled, or

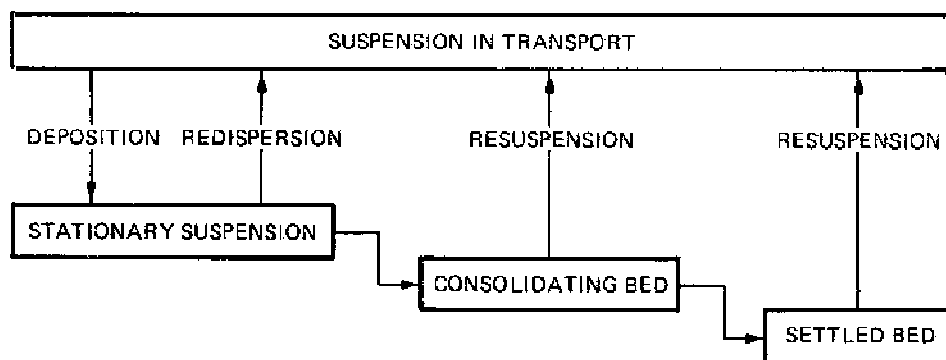

Figure 4-2. Schematic representation of the physical states of cohesive sediment in estuarial waters (from Mehta et al. 1982)

fully consolidated, bed eventually results. Relatively thin deposits, on the order of a few centimetres thickness, practically consolidate in a week or two, but thick deposits may remain underconsolidated for months or even years.

h. Erosion. Immediately following slack water, a stationary suspension begins to erode or resuspend rapidly as the flow speed picks up. This is often referred to as mass erosion or redispersion (Parker and Kirby 1982). A fully consolidated or a settled bed erodes by a slightly different process. At relatively low bed shear stresses (or velocities), aggregates from the bed surface are entrained. At high shear stresses, or under rapidly accelerating flows, erosion is much more rapid, and relatively large chunks of sediment are entrained.

i. Depth Effects. In deep estuaries, there can be a significant lag between nearbed suspension response to deposition/erosion and the corresponding response at the surface. This type of hysteresis effect is set up as a result of the time it takes for sediment to diffuse upward and the corresponding sediment settling time.

4-6. Impact of Tidal Flow and Geometry. Sedimentary boundary conditions are critically important in governing estuarial sediment transport. At the mouth, tidal forcing is determined by the open coast tide characteristics as well as the geometry of the mouth itself. At the upstream end, beyond the influence of tides, the river discharge hydrograph and sediment inflow are key factors. In addition, runoff, direct precipitation, and bank erosion by currents and waves can be significant factors that contribute to the overall sedimentary regime.

a. Deposition. Deposition-dominated environment includes flood and ebb deltas near the mouth, shoal areas within the estuary including natural and dredged navigation channels, and basins including ports and marinas.

b. Erosion. Sites where erosion is predominant tend to be localized in comparison with sites of deposition, although sometimes large previously deposited shoals disintegrate in the absence of sediment supply.

c. Mixed Environment. In a mixed deposition/erosion environment in which net scour or shoaling is small, e.g., as would occur if the regime were in a state of "live bed" equilibrium, the rates of deposition and erosion can be high individually, and these would cause significant "to and fro" transport of sediment during a tidal cycle or over a spring-neap cycle.

d. Waves. Shallow- and intermediate-depth water waves provide a critically important mechanism for incipient motion and resuspension of bottom sediment. The sediment is then advected by the tidal currents. Waves breaking at the banks can also cause a measurable increase in sediment transport rates in some cases.

e. Wind. Aeolian transport is usually ignored in typical estuarial transport calculations. However, in certain well-defined areas such as small

basins, windblown material can form a significant fraction of the total deposit, particularly where sediment transport rates in the water body are not high.

f. Sea Level Rise. The rise of sea level relative to land should be considered when comparing bathymetric surveys taken at different times, for the purpose of determining long-term rates of shoaling or scour (Krone 1979).

g. Geometry. The impact of estuarial geometry on sediment transport is associated with the effect of geometry on flows that transport sediment. For example, it is quite common to find relatively well-defined flood- and ebb-dominated channels with consequent implications for the direction of sediment transport. Furthermore, deep, dredged channels often are natural sites for sedimentation as are basins constructed along estuarial banks. Natural floodplains are historic sites for deposition of alluvial material, which provides fertile soil necessary for agriculture. Diversion of tributary flows for agricultural or urban uses can have deleterious effects, on both sedimentation as well as water quality (McDowell and O'Connor 1977).

4-7. Sediment Characterization. Characterization tests for the sediment depend on the nature of sediment, i.e., coarse or fine-grained. It may be necessary to separate the coarse and fine fractions and analyze them separately.

a. Coarse Sediment. For coarse sediment it is typically useful to evaluate particle size distribution or, preferably, settling velocity distribution; material density and bed porosity; and, sometimes, the angle of repose.

b. Analysis. Size distribution is customarily obtained through sieve analysis in terms of selected sieve sizes. It is preferable to characterize sediment by its settling velocity, which is a more fundamental property than size as far as sediment transport is concerned. Details on particle size and settling velocity measurements as well as material density and bed porosity are found in Vanoni (1975). The angle of repose is a basic property associated with bank stability as well as with incipient grain movement (Lane 1955; Mehta and Christensen 1983).

c. Cohesive Sediment. For cohesive sediment, the problem of characterization is more complex than that for coarse-grained material, because sediment aggregate properties depend on the type of sediment, the fluid, and the flow condition itself.

d. Characterizing Sediment. For characterizing the sediment, it is recommended that the following be specified through various laboratory measurement procedures:

(1) Grain size distribution of dispersed sediment using, for example, the standard hydrometer test (ASTM 1964).

EM 1110-2-1607  
15 Mar 91

(2) The relationship between the median (by weight) settling velocity and the suspension concentration of the flocculated sediment, noted in Owen (1976).

(3) Clay and nonclay mineralogical composition through X-ray diffraction analysis (Grim 1968).

(4) Organic content (Jackson 1958).

(5) The cation exchange capacity, which is a measure of the degree of cohesion of the clay (Grim 1968).

e. Characterizing Fluid. For characterizing the fluid, it is recommended that the following be specified:

(1) Concentrations of important cations (e.g., sodium (Na<sup>+</sup>), calcium (Ca<sup>++</sup>), and magnesium (mg<sup>++</sup>) and anions (e.g., chlorine (Cl<sup>-</sup>) and sulfate (So<sub>4</sub><sup>-</sup>)).

(2) Total salt concentration.

(3) pH.

(4) Fluid temperature during measurements as well as in laboratory experiments for determining the rates of erosion and deposition.

Items 1, 2, and 3 can be determined through standardized chemical analysis procedures.

f. Sodium Adsorption Ratio. Recognizing that sodium, calcium, and magnesium are three comparatively more abundant and influential cations, the sodium adsorption ratio (SAR) is found to be a convenient parameter for characterizing the influence of fluid chemistry on cohesive sediment transport behavior. SAR, total salt concentration, pH, and fluid temperature have been shown to control the critical shear stress for erosion of soils with uniform bed properties (Ariathurai and Arulanandan 1978).

g. Core Samples. Inasmuch as consolidation increases bed density, it is important to obtain representative in situ bottom cores for determining the depth distribution of the density (bulk and dry) of the bed. This information enables a conversion between deposition and erosion of sediment mass per unit time and the corresponding changes in the suspension concentration (mass per unit volume).

h. Rheological Properties. In studies in which dissipation of fluid energy within the bed plays an important role, e.g., wave-mud interaction, it is essential to evaluate the rheological properties, the most important one being the viscosity, which has been found to be related to sediment concentration in an approximate manner (Krone 1963). Most commonly this includes the Bingham yield stress, for a comparatively simplified rheological description.

i. Usage of Collected Data. The characterization of sediment is necessary to aid in the identification of transport and deposition processes. Preplanning for specific project data collection programs is essential so that the proper type, quantity, and data analysis can be conducted. The preceding and following paragraphs describe various field tests and sediment analysis, which may or may not be required. The amount and type of data and required procedures and tests should be determined during the project planning stage. Too much or too little data could be costly and detrimental to the project. These chapters and appendices provide general guidance; specific guidance can be found in Appendix A or through the Hydraulics Laboratory, WES.

4-8. Transport Parameters. The movement of sediment is sensitive to flow speed and direction, and it is particularly important to characterize the flow regime including the influences of salinity, wind, and related factors for a comprehensive evaluation of the overall sediment transport regime.

a. Settling Velocity. Particle settling velocity is both an important sediment-characterizing parameter as well as a deposition-related parameter. The critical shear stress is the important erosion-related parameter. Field and laboratory procedures for evaluating these and associated parameters, where cohesionless sediment transport is concerned, are well documented in literature (Vanoni 1975). Use of sediment transport formulas without adequate calibration of the formula may lead to major errors in transport rate prediction.

b. Processes. Cohesive sediment transport processes that require parameter characterization include settling and deposition, consolidation, and erosion.

c. Procedures. Settling is principally characterized by the relationship between the settling velocity and suspension concentration. There are basically four procedures for evaluating this relationship, each under a specific set of conditions and therefore yielding results peculiar to those conditions:

(1) Tests in a laboratory settling column (ASTM 1964; Krone 1962; Hunt 1980).

(2) Tests in a laboratory flume (Krone 1962; Mehta and Partheniades 1975).

(3) Use of in situ settling tube. This tube, designed originally by Owen (1971), allows for on site measurements. By performing the settling test almost immediately following sample withdrawal from the water body, the aggregates are presumed to remain unaltered in composition.

(4) Comparison of measured suspended sediment concentration profiles (depth-concentration variation) with analytic prediction (O'Connor and Tuxford 1980; Mehta et al. 1982; Vanoni 1975).

d. Field Measurement. For prototype application, the in situ tube is preferred for measurement of settling velocity. Extensive measurements of this nature have, for instance, been obtained in the Thames Estuary in England (Burt and Stevenson 1983). Laboratory flume tests should be used for supplementary and/or confirmatory evidence. The same holds for settling columns. Different approaches will yield different results, in general.

e. Shear Stress. The rate of deposition depends on the rate at which the fraction of the settling sediment deposits, the remainder consisting of aggregates that break up near the bed under the action of bed shear stress and are reentrained. The critical shear stress for erosion  $\tau_s$  can be evaluated from laboratory flume experiments (Krone 1962). For a uniform sediment (narrow primary particle size distribution), single values of settling velocity  $W_s$  and critical shear stress for deposition  $\tau_{cd}$  will suffice. For a graded sediment (e.g., a typical mud with a relatively wide range of sizes from coarse silt to fine clay),  $W_s$  and  $\tau_{cd}$  will have corresponding wide ranges.

f. Gelling. Freshly deposited mud undergoes increases in both density and physicochemical changes associated with interparticle bonds, known as gelling. Following bed formation, gelling is complete in about a day (Krone 1983).

g. Bed Thickness. From the perspective of estuarial sediment transport, density increase and physicochemical changes are important because these in turn control corresponding changes in the bed shear strength with respect to erosion (Mehta et al. 1982). For relatively thin beds, e.g., on the order of a few centimetres in thickness, consolidation is practically complete in a period on the order of 1 or 2 weeks, and the rate of bed deformation becomes small in comparison with its value immediately following bed formation. Density and erosional shear strength become nearly invariant with further passage of time.

h. Bed Shear Strength. Investigators have found an approximate power-law relationship between the bed shear strength and density, specific to the type of sediment and fluid used (Migniot 1968; Owen 1970; Thorn and Parsons 1980).

4-9. Causes of Sediment Deposition. The rate of sediment mass deposition increases with increasing settling velocity  $W_s$  and with suspension concentration  $C$  and decreases with increasing bed shear stress  $\tau_b$ , given  $\tau_{cd}$ . It follows that the mass of sediment deposited depends on the availability of entrained sediment, its settling velocity, and flow condition as reflected primarily in the bed shear stress. This type of reasoning is generally applicable to cohesive as well as cohesionless sediment.

a. Definition. A deposition-dominated environment is characterized by a region of relatively low bed shear stress in which the rate of supply of sediment to the bed well exceeds the rate of depletion by erosion (Ippen 1966; Mehta et al. 1982).

b. Long-Term Monitoring. Estuaries tend to be in a state of quasi-equilibrium as far as the hydrodynamic and sedimentary processes are concerned. Superimposed on these processes of annual cycle of variation of tides, freshwater flows, salinity intrusion, and sediment transport, longer period variations in the physical regime also occur. Slow filling up of the existing deep channel or thalweg, coupled with scouring of a new channel elsewhere, may occur over a 10-20 year period (Calcutta Port Commissioners 1973; McDowell and O'Connor 1977). It is therefore critically important to understand the long-term estuarial behavior through an adequate monitoring program, particularly one involving extensive bathymetric surveys.

4-10. Consolidation. Consolidation is the volume change in deposited material with time. Fine or cohesive sediment deposits consolidate. Hindered settling can result in the formation of fluid mud. As sediments consolidate toward fully settled states, a self-weight component may be important to further consolidation.

a. Fluid Mud. The formation of fluid muds can alter the transport mode of fine-grained sediments and is therefore important to sediment dispersal analyses. Fine-grained material with high moisture or low bulk density has relatively low shear strength and can flow under the effects of gravity or the overlying flow. Fluid mud layers often collect in navigation channels.

b. Consolidation Tests. The amount of consolidation that disposed dredged material will undergo can be predicted by settling tube or accelerated consolidation tests and models (Montgomery 1978; Cargill 1983 and 1985). Similar zone or column settling tests can be performed on fine-grained sediments to determine settling characteristics over a range of high suspension concentrations. If self-weight consolidation modeling is to be carried out, special controlled-strain consolidation testing is required. Controlled-strain consolidation testing is performed at the WES Geotechnical Laboratory.

4-11. Physical Models. Physical hydraulic models are scaled representations of prototype estuaries. Physical hydraulic models can be important tools in sedimentation analysis of estuaries, and should be considered as one component of a program to study sedimentation if three-dimensional flow effects are known or suspected to be important. Most physical modeling of estuaries is performed at the WES Hydraulics Laboratory.

a. Scale. Sediments and sediment transport rates must be scaled in the models. Scale ratios for coarse sediments transported by quasi-steady hydraulic shear stresses are an acceptable compromise permitting useful predictions. Shoaling indices are employed. Scale ratios for fine sediments are more difficult to establish, and qualitative methods are used for hydraulic model prediction.

b. Processes. Physical hydraulic models have been successfully used to predict tidal currents, circulation, riverflows, salinity distributions, and dispersion processes. Many or all of these processes influence

sedimentation. Physical hydraulic models have been successfully incorporated into hybrid model studies as will be discussed in a later section. Because they are real, physical representations, physical hydraulic models display system dynamics in a manner that can be readily assimilated by both modeler and lay persons. Physical hydraulic models can simulate long periods of time, spring-to-neap cycles, or hydrographs.

c. Test Procedures. During model verification hydraulic and salinity adjustments are made first. Sedimentation is verified to shoaling volumes computed from a series of prototype hydrographic surveys. Methods are developed during model verification to introduce, distribute, and collect model sediments.

4-12. Analytical Models. Analytical models are considerable simplifications of estuarine sedimentation processes but are useful for such tasks as screening, checking the reasonableness of other methods, and identifying important processes. The following are some examples of analytical models.

a. Prototype Data Treatment. Analytical models are a method of treating prototype data. Time series velocities and concentrations can be integrated using assumed critical shear stresses to estimate depositional flux or net deposition. Several equations can be used for this purpose and form the basis for a closed-form mathematical solution.

b. Flux Analysis. An alternate or supplemental analysis to that of the last section is horizontal suspended flux analysis using prototype data. Horizontal flux analysis makes no assumption about deposition characteristics of sediments. Deposition or erosion is inferred from longitudinal gradients of sediment flux in this method. Measurements of currents, salinities, and suspended sediment concentration over depth and over a tidal cycle can be used to calculate the total fluxes at a station.

c. Depositional Models. Zero-dimensional (in the spatial domain) models can be applied to basins or to channels with relatively steady and uniform flows. A slightly more complex model incorporating tidal prism input could be applied to an estuary as a whole or to tidal basins (Appendix D).

4-13. Numerical Models. A number of estuaries have been numerically modeled at the WES Hydraulics Laboratory. A two-dimensional (in the horizontal plane) numerical sedimentation model is included in the Corps' TABS modeling system. TABS is available to qualified users Corps-wide. Training on the TABS system is available at WES.

a. Model Processes. Numerical sediment models are transport models with nonconservative bed interaction terms. Sediments are numerically transported by advective currents and by diffusion; therefore, sediment models require that currents be supplied by a hydrodynamic (usually numerical) model. Interactions between suspended sediments and the bed are governed by process equations in sediment transport models. Coarse sediment-bed interaction terms usually depend on the gradient of the transport potential of the material.



Fine sediment-bed interaction terms consist of process description for erosion and deposition. Bed structure or layering is usually modeled in some way to account for changes in density and shear strength with depth in fine sediments. Numerical sediment models are classified by their dimensions, sediment type, and the equations that are solved.

b. Model Applications. Numerical models are the most advanced modeling method available for simulating sedimentation. Numerical modeling, like other modeling methods, remains an art-science, and successful application to real problems depends heavily on the skill and intuition of the model user.

4-14. Hybrid Models. Combining two or more models in a solution method is a hybrid model. Hybrid models attempt to use the best modeling methods available for each "part" of sedimentation problems: current structure and sediment transport. The following are the most frequently used hybrid techniques, starting with the most rigorous.

a. Physical-Numerical. The physical-numerical hybrid modeling approach uses a physical model to predict currents and a numerical model to predict sediment transport. This approach has been successfully applied to a number of estuarine sediment problems at the WES Hydraulics Laboratory (McAnally et al. 1983). The physical model can be used to generate boundary conditions for the detailed numerical mesh or grid of the sediment model.

b. Physical-Analytical. The physical-analytical hybrid modeling approach uses a physical model for currents and an analytical model to predict sedimentation. Velocities and bed shear stress histories can be collected at various points in the physical model. Physical model results can then be extended using some appropriate analytical expression(s).

c. Numerical-Analytical. A numerical-analytical hybrid model uses a numerical model to predict sedimentation. The numerical-analytical hybrid technique avoids the costs associated with numerical sediment modeling, but at the expense of considerable rigorosity. The results from a hydrodynamic model can be used to address limited questions on sedimentation with analytical models. The shear stress at various points can be evaluated to predict an indication of deposition or erosion (Hauck 1989).

4-15. Field Data Requirements. All analyses depend on field data. Field data acquisition may be the most costly part of a sedimentation study. Required data can be grouped into system definition and behavior and boundary data. The following discussion is limited to sediment data requirements.

a. A good way to determine system behavior is to conduct a boat survey in which currents, salinities, and suspended sediment concentrations are collected at short time intervals (half hour) with depth at several stations across several cross sections over a tidal cycle. Tides at several locations and supporting measurements or observations of winds and other conditions are also required.

b. Bed sediment properties are required for system definition. Methods for sediment characterization were described in earlier sections. Fine-grained sediments require settling velocity evaluation, since settling is not related directly to individual particle size. Vertical profiles of suspended sediment concentration can be used to deduce settling velocities. Settling velocities can be estimated in the field using settling tube samplers. Settling experiments in the field are preferred to laboratory tests, although conditions may require the latter. It is usually not practical to carry out enough settling tests in the field to obtain sufficient spatial and temporal coverage. Therefore it is necessary to supplement field settling data with analysis of many vertical suspended sediment profiles or high-resolution particle size analysis (such as Coulter Counter analysis). Water column measurements of sediment concentration should be supplemented by some measurements near or at the sediment bed-water interface. Specifically, the presence of fluid mud should be checked using acoustic soundings, densimetric profiling, or low-disturbance coring devices. Shallow coring is also a good method of determining bed structures such as armoring, density differences, or layering.

c. Classification by the methods described in earlier sections may be useful in estimating sediment properties from existing data. Settling velocities, critical shear stresses for erosion and deposition, and the densities of fine-grained deposited material are properties that might require supplemental laboratory study.

## CHAPTER 5

## DESIGN CONSIDERATIONS

## Section I. Control Works

5-1. Purpose. Control works are constructed in estuaries to confine channels to definite alignments, reduce or relocate shoaling, reduce wave action in harbor areas, improve navigation conditions, prevent or reduce salinity intrusion, or prevent or reduce flooding.

5-2. Types. The principal types of control works in estuaries are as follows:

a. Breakwaters. These structures are partial barriers at the entrance to embayments, coves, or channels in water subject to severe wave action for the purpose of providing shelter from waves. Examples are shown in Figure 5-1.

b. Training Dikes. Training dikes may be longitudinal structures extending along the course of the waterway in a critical reach, or alternatively a series of structures extending out from the shore generally perpendicular to the currents to guide or direct the currents, reduce channel shoaling, or prevent bank erosion. Examples are shown in Figure 5-2.

c. Salinity Barriers. One type is a dam that extends completely across the waterway to exclude saline waters from upstream areas. This type necessarily includes spillways to discharge flows from the upland, and often one or more sets of locks to permit vessels to navigate beyond the barrier. An example of this type of salinity barrier is shown in Figure 5-3. Another type of salinity barrier is the submerged sill. This type is intended to reduce salinity intrusion by disrupting the bottom salinity wedge as it intrudes upstream or to induce vertical mixing of the salt and fresh waters. The sill can be permanent, constructed of stone or other permanent material, or temporary, constructed of sand. A sketch of this type of barrier is shown in Figure 5-4.

d. Hurricane Barriers. Hurricane barriers are structures that extend completely across the waterway, except for gaps at navigation channels. The purpose of hurricane barriers is to reduce the magnitude of hurricane surges upstream of the barrier. An example is shown in Figure 5-5.

e. Revetments. Revetments are constructed along the banks of the waterway to prevent erosion by currents and waves. An example is shown in Figure 5-6.

f. Diversion Works. These works intercept freshwater discharges from upland areas and cause them to be discharged to sea using an adjacent waterway. An example is shown in Figure 5-7.

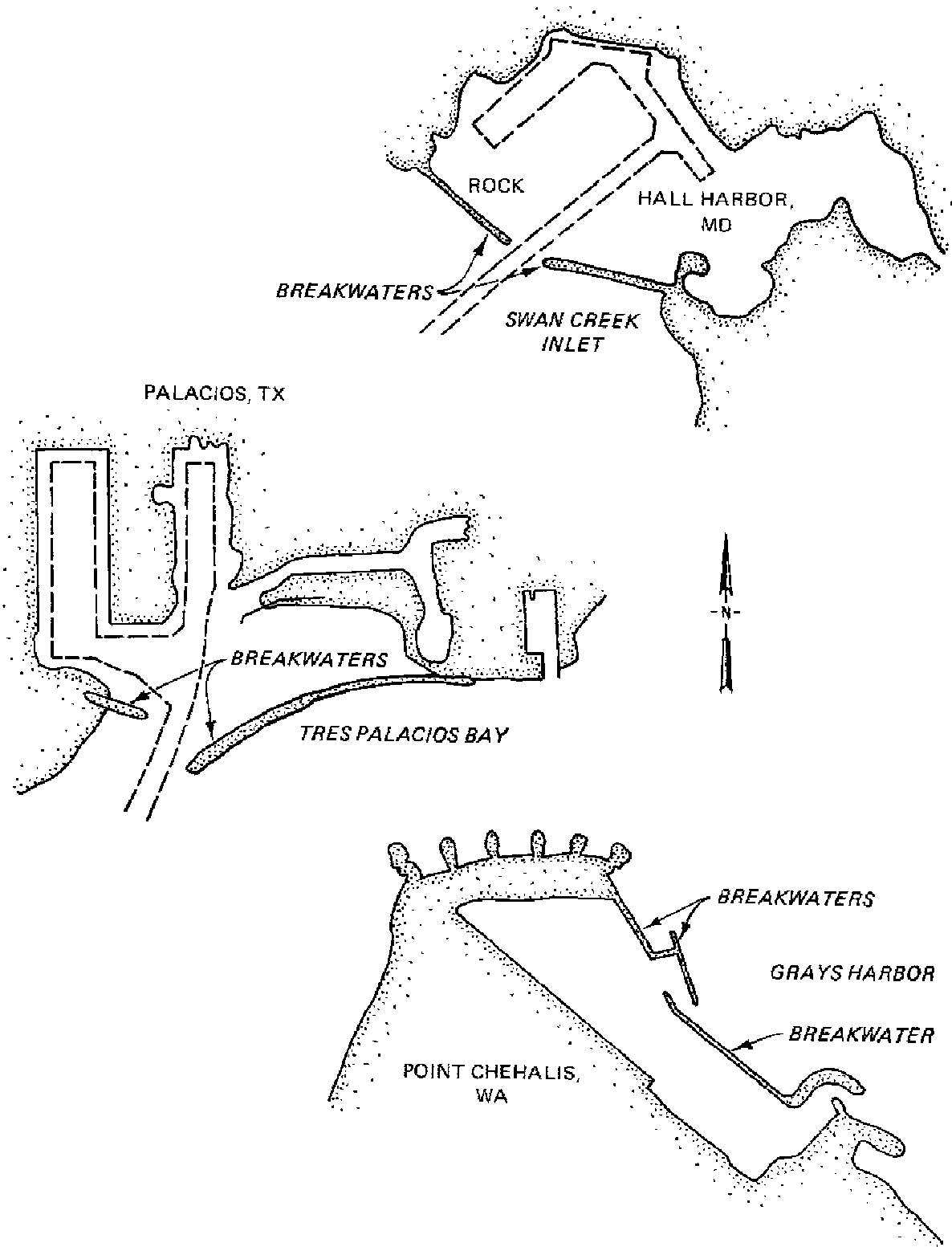

Figure 5-1. Estuarine breakwaters

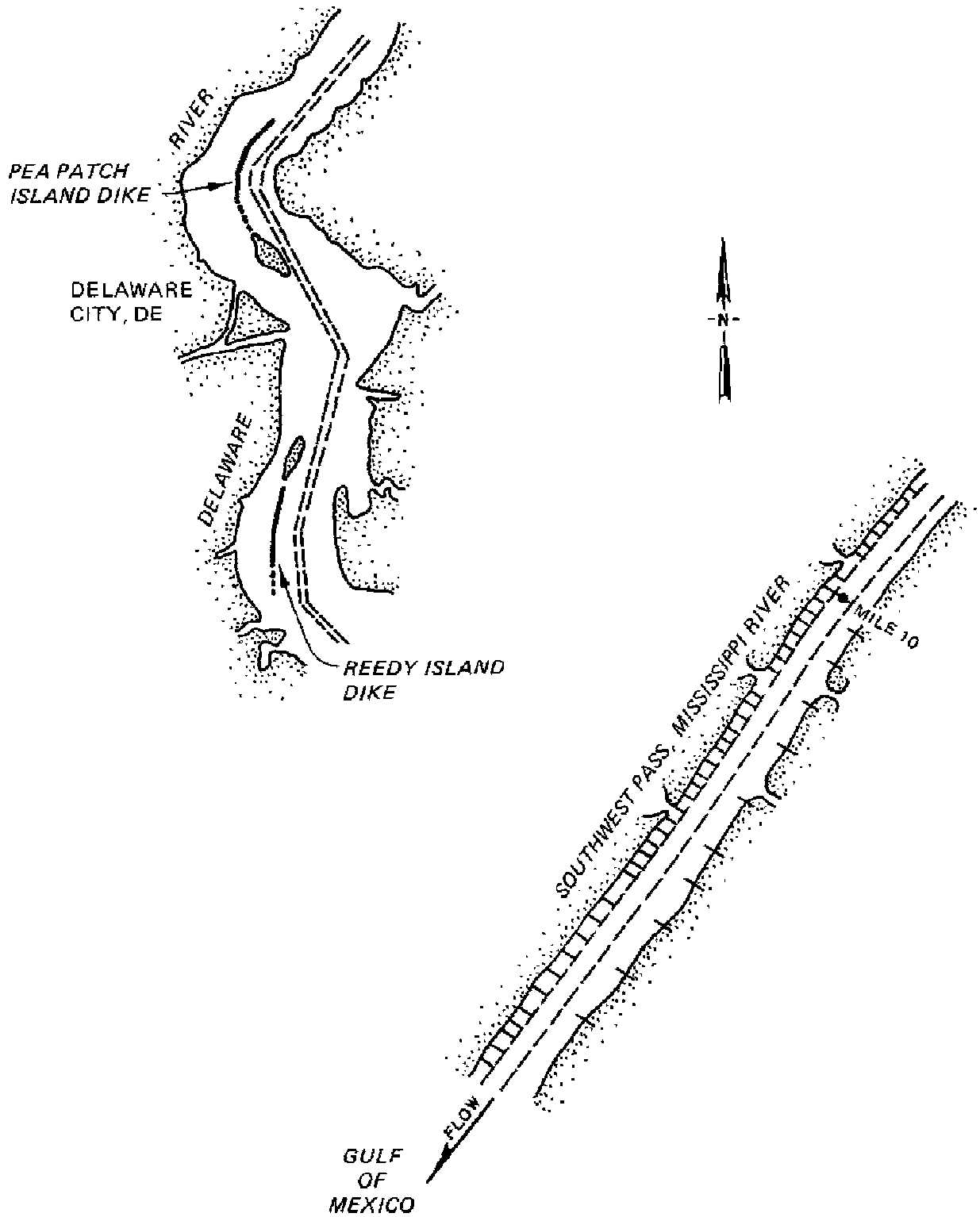
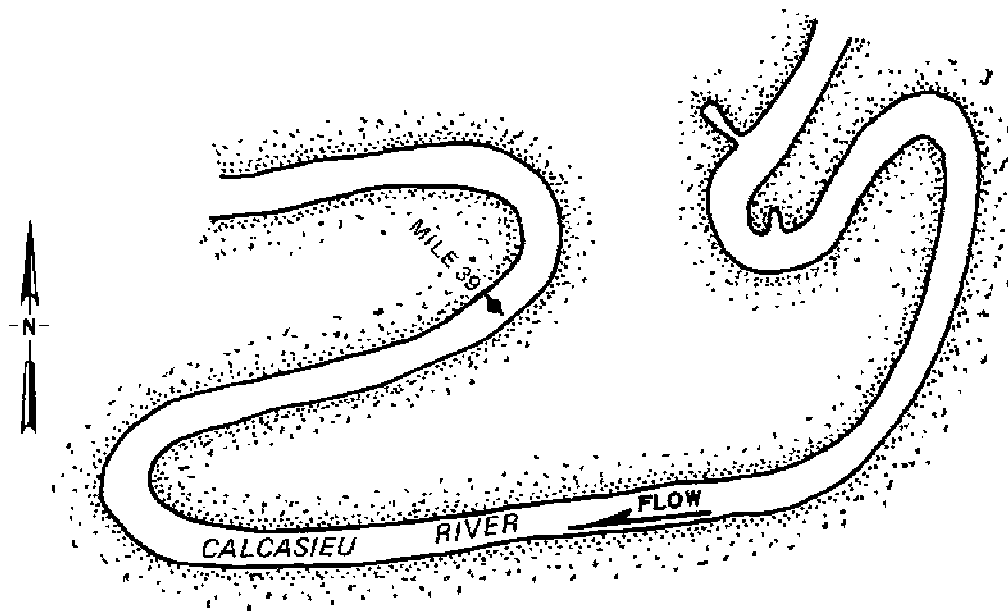
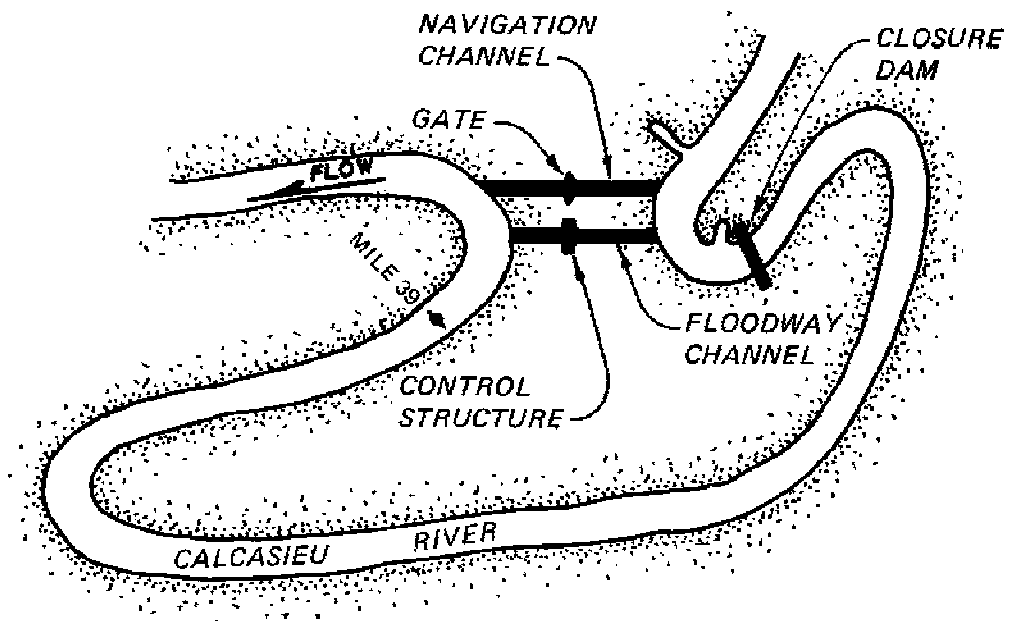

Figure 5-2. Training dikes



a. MEANDER PRIOR TO CONSTRUCTION



b. MEANDER WITH SALINITY BARRIER IN PLACE

Figure 5-3. Salinity barrier structure

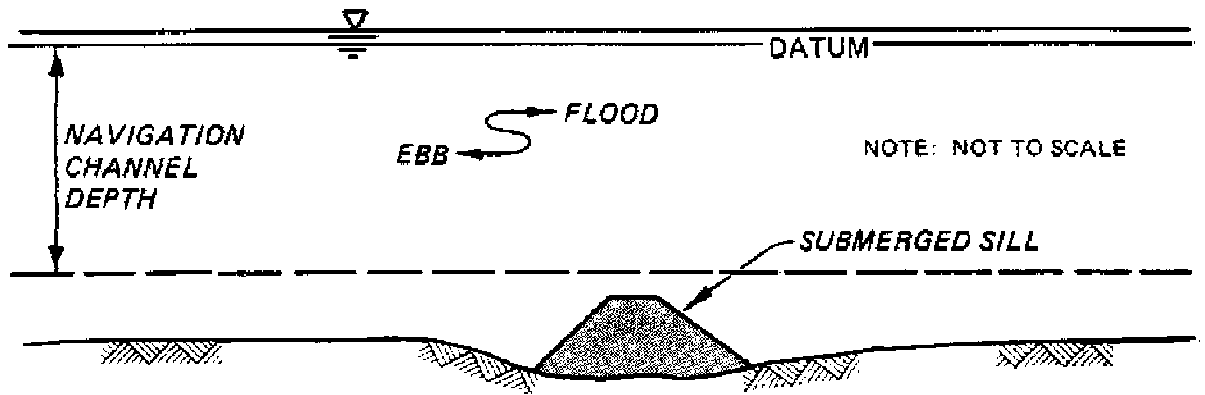

Figure 5-4. Submerged sill salinity barrier

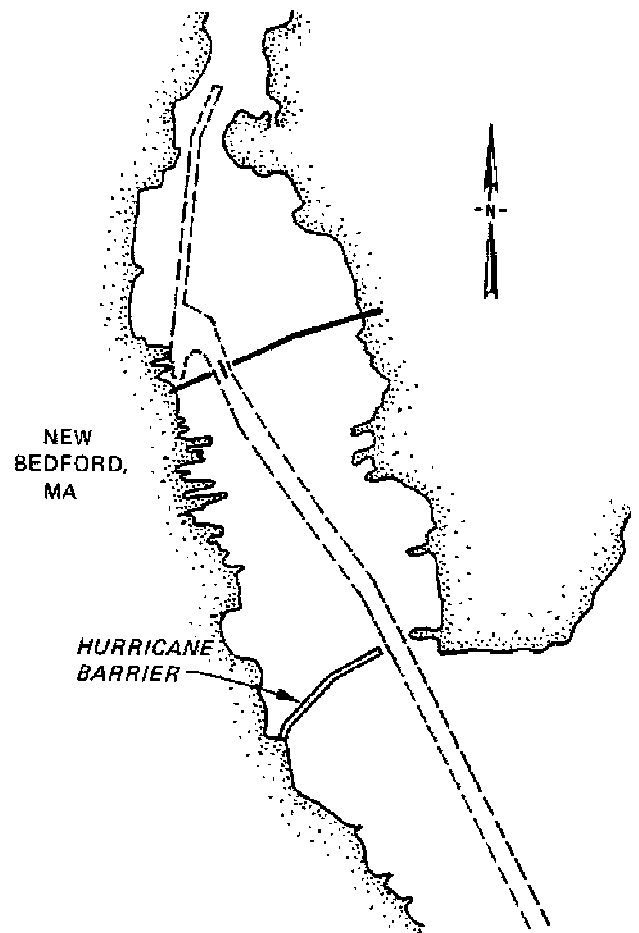

Figure 5-5. Hurricane barrier

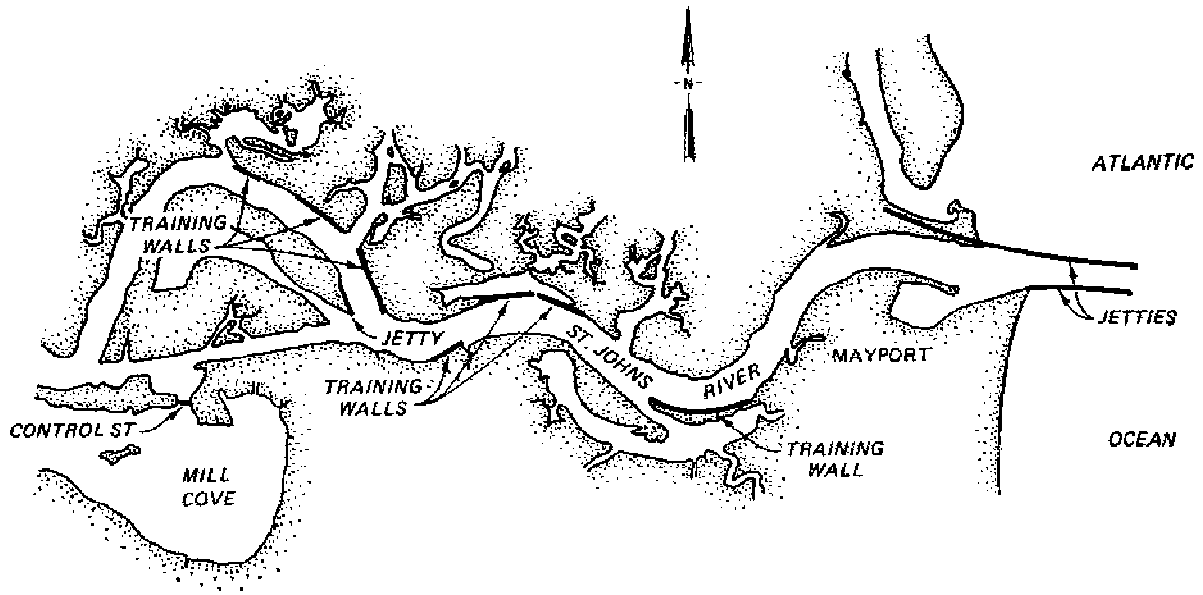

Figure 5-6. Revetments

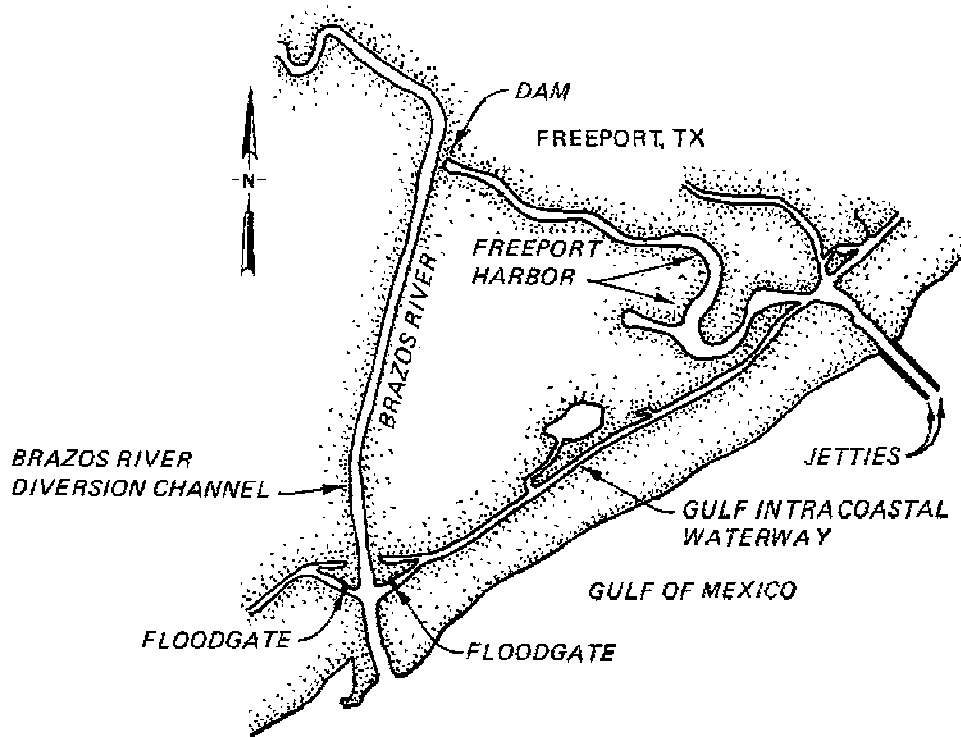

Figure 5-7. Flow diversion



g. Sediment Traps. These traps (or sediment basins) are areas in the waterway that are excavated to depths and widths equal to or greater than those of the adjacent navigation channel. They generally extend across the navigation channel although sometimes they are located in a side channel that is connected with the navigation channel. Their purpose is to reduce maintenance dredging costs by accumulating sediments within the trap rather than in scattered deposits along the channel in areas sometimes difficult to dredge or remote from disposal sites. Examples of estuarine sediment traps are given in Figure 5-8.

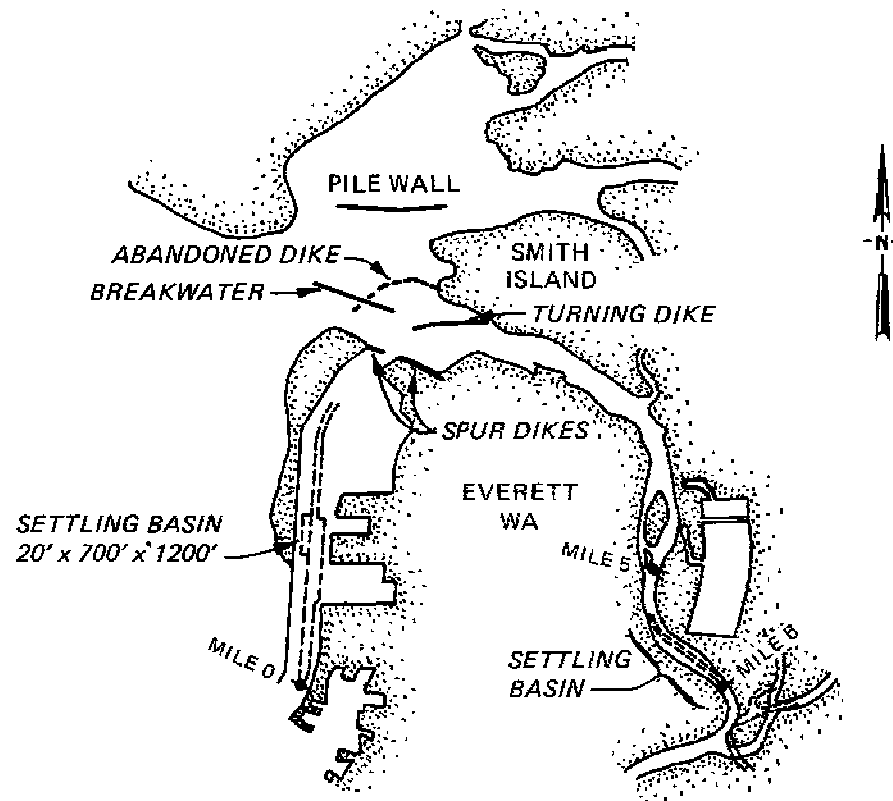

Figure 5-8. Sediment trap

## Section II. Design Factors

5-3. General. In control works projects, there are usually six factors that must be addressed by hydraulic engineers during the design of the project. The impact of the project on any of these factors can control the design of the project. These factors are navigation safety, salinity, water quality, navigation channel sedimentation, general sedimentation, and flooding.

5-4. Navigation Safety. In control works projects where structures hazardous to navigation are planned adjacent to or near navigation channels, navigation safety may be a controlling factor in project design. Navigation safety may also be a controlling factor in control works projects that cause changes in currents along navigation channels, since altered current patterns can

adversely impact vessel navigability. The recent development of the numerical ship/tow simulator has greatly enhanced the capability to solve existing navigation safety problems and to evaluate proposed designs to eliminate problems before construction. For detailed information on the ship/tow simulator and navigation safety, see Hewlett, Daggett, and Heltzel (1987); Huval, Comes, and Garner (1985); and Huval (1985) as well as EM 1110-2-1613.

5-5. Salinity. Freshwater supplies often are derived from the freshwater zones in the upper portions of many estuaries. The fresh water is typically used for municipal, agricultural, or industrial purposes. The development of any control works project within an estuary that might cause increased intrusion of salt into the estuary can be a threat to existing freshwater supplies. In such cases increased salinity intrusion can be a controlling factor in designing the control works project. Estuarine ecological features such as oyster beds or fish and shrimp nurseries can be significantly harmed by changes in the local salinity regime. Thus salinity can be a design factor in control works projects that alter the salinity regime in portions of an estuary.

5-6. Water Quality. Many control works projects within estuaries have the potential of changing circulation patterns and flushing rates. Flushing rates can be a controlling design factor if reduced flushing results in concentrations of dissolved or suspended materials being outside acceptable or safe limits in portions of an estuary.

5-7. Channel Sedimentation. Changes in channel sedimentation can be a controlling factor in project design if sedimentation is significantly increased or redistributed from low-cost to high-cost maintenance dredging areas.

5-8. General Sedimentation. Changes in general estuary sedimentation patterns can be a design factor in control works projects if the ecology of the estuary is threatened. For example, a benthic community could be threatened by a control works project that causes increased sedimentation or erosion in its bottom area of the estuary.

### Section III. Siting of Control Works

5-9. Flooding. Control works projects within estuaries also have the potential of acting as a flood-control measure or increasing local flooding. During the project planning stage, it should be considered that the control works may function as barriers during peak hydrograph and actually create or increase localized flooding.

5-10. Estuarine Breakwaters and Jetties. The principal criteria to be observed in the layout of an estuarine breakwater are adequate depths in the area to be protected from waves; adequate depths in the approaches to the harbor entrance; and an entrance that will minimize wave action within the harbor while providing adequate clearances for navigation.

a. Design Considerations. The orientation of the entrance should be

such that entrance approaches and departures can follow a course generally in the direction of the more severe waves. Safe navigation will generally require an entrance channel much wider than that of the interior channel, since control under severe wave conditions will tend to be difficult for both large and small vessels. Bar channels and entrances partly protected by jetties and training structures will require special studies of tidal currents, waves, littoral transport, and shoaling tendencies to determine the optimum relations with regard to channel width, cross section, alignment, and degree of exposure. Channel widths in entrances will have to be judiciously selected based on the analysis of conditions at each project. For detailed guidance see EM 1110-2-1613.

b. Waves. The design of the entrance for the purpose of excluding or minimizing the propagation of waves into the harbor may be accomplished by procedures described in the Shore Protection Manual (US Army Engineer Waterways Experiment Station 1984).

#### 5-11. Salinity Barriers.

a. Dam Type. The dam type of salinity barrier should be located as far upstream as is practicable without defeating the purpose of the structure in order to interfere with navigation as little as possible. Where feasible, it should be located in a reach where vessels can approach the locks on a straight course for at least a mile before entering the guide structure. The approach reach should be free of large waves and crosscurrents, which might throw the vessel off course and make the approach to the locks difficult, see EM 1110-2-1611 and 1110-2-1613 for details of navigation channel design.

(1) Lockages will admit salt water to the upstream pool. If there are many lockages per day, it is likely that the pool will become contaminated by salt water, possibly to a greater extent than would have been the case without the barrier. There are several methods that have been employed successfully to prevent or minimize this contamination. Among these are the following: separate emptying and filling systems; a "scavenger" pool with a discharge pipeline extending through the barrier; a hinged-leaf barrier in the lock; and a pneumatic barrier. Details of these devices are given in Abraham and Burgh (1964), Wicker (1965), and Ables (1978).

(2) The barrier will impound upland discharges. During floods, the impoundment may be high enough to cause damage to shoreline installations unless the spillway is adequate to pass such discharges with a minimum of backwater effect, or unless levees are constructed along the shoreline for a sufficient distance upstream of the barrier to extend beyond the limits of such backwater effects. The normal elevation of the pool with the barrier in place may cause damages to shoreline property.

(3) The barrier should be high enough to be secure against overtopping by hurricane surges and superimposed storm waves, if it is in a locality subject to hurricanes, or it may be economical to provide lower crest elevations, depending on the uses made of the impounded water and the efficiency of

the scavenger pool that may be provided to remove the salt water.

(4) The barrier will cause important modifications of the regimen of the waterway both downstream and upstream. Downstream, the tide will rise higher and fall lower than before, the effect being greatest at the barrier and diminishing downstream. Shoreline properties will be inundated to an extent, and navigation depths decreased. Shoaling may become more serious. Upstream from the dam, the tide will be eliminated as will any existing salt-water penetration. Also the waterway above the barrier could be transformed from free flowing to an impounded pool. Typically riverflow will be maintained by operation of a control structure. An approximation of the order of magnitude of the changes may be computed by methods described in Wicker (1965), Dronkers-Schoenfeld (1955), Ippen and Harleman (1961), and McDowell and O'Connor (1977).

(5) The changes in the regimen of the waterway may be so great and of such significance that consideration should be given to conducting a numerical or physical hydraulic model study. The investigation should include consideration of the changes in the regimen downstream, the potential effects on shoaling both upstream and downstream of the barrier, the effects on pollutant accumulations upstream, the extent and concentration of salinity intrusions as a result of lockages, the design of the scavenger pool and appurtenances to prevent intrusions, and the elevations of the pool upstream at normal and at various flood discharges.

b. Submerged Sill.

(1) A second type of salinity barrier, the submerged sill, is designed to retard salinity intrusion upstream of the sill. Because the sill crest must be below the elevation of the authorized navigation channel bottom, it must be placed in a location naturally deeper than the authorized navigation channel depth. The vertical salinity structure at the sill location should be at least partially stratified, since the disruption of the bottom density current along with increased vertical mixing are the factors that make the sill effective in reducing upstream salinity intrusion. The greater the height of the sill, the greater the potential for reduced salinity intrusion upstream. The sill may be designed to be permanent or temporary. Examples of the design of both types are given in US Army Engineer District (USAED), San Francisco (1979), and Johnson, Boyd, and Keulegan (1987). The only reliable predictive techniques to investigate the effectiveness of submerged sills are physical and numerical hydraulic models.

(2) A submerged sill of the temporary type was successfully used in the Lower Mississippi River during the 1988 drought to limit saltwater intrusion. The sill, constructed of locally dredged river sands and located near river mile 63, limited the salt water approaching the freshwater intake for the city of New Orleans. The US Army Engineer District, New Orleans, designed the sill to erode away at high river discharges.

5-12. Hurricane Barriers. Hurricane barriers should be located as far downstream as is practicable, as they not only protect a larger area, but their effects on the heights of hurricane surges and on the normal regimen downstream of the barrier will be felt over lesser distances. (The fact that such structures may have important effects downstream as well as upstream should not be overlooked.) They should be located where the approaches to the gap for navigation will permit a straight sailing course for at least a mile, and where such a course will not be subject to crosscurrents and frequent severe wave action.

a. To reduce surge transmission as much as possible, the gap for ungated barriers should be as narrow and shallow as the needs of navigation will permit. The sill should be deep enough to provide adequate clearance for the vessels of the foreseeable future that will be employed in the commerce of the waterway. It should be remembered in this connection that the current velocities through the gap will undoubtedly be greater than the normal currents along the course of the waterway, and that there will be adverse effects for some distance both upstream and downstream of the gap. The width of the gap must be determined with these considerations in mind.

b. The barrier will have effects on the regimen of the waterway both upstream and downstream. Shoaling may be accelerated; the tides may rise higher and fall lower on the downstream side; the tide range may be decreased upstream; and the elevation of mean river level may be increased.

c. A satisfactory design of the navigation gap usually cannot be accomplished without benefit of a numerical or physical hydraulic model study and a ship simulator study. From these studies, the best arrangement and location for the barrier as well as for the navigation gap can be determined. These studies will also provide reliable information on the effects of the barrier, with gaps of various dimensions installed, on the regimen of the waterway upstream and downstream, as well as on the navigability of the gaps tested. Tests including a range of upland discharges should be run in the hydraulic model to determine the backwater effects of the barrier.

d. The barrier should be high enough to protect against the design hurricane surge. Surge heights may be computed according to the procedures described in EM 1110-2-1412.

5-13. Training Dikes. In reaches of the waterway where it is necessary to locate the navigation channel elsewhere than in the natural thalweg, the currents will be at an angle to the channel rather than parallel with it, and shoaling is likely to be heavy. It may be possible to force the currents into a course that parallels the navigation channel rather than the thalweg (which then will shoal and the navigation channel will become the new location of the thalweg) by constructing dikes. These may be either parallel with the navigation channel, or consist of a system of spur dikes extending out from the shore into the current that is to be diverted. The effects of longitudinal dikes on the regimen of the waterway are generally local. As spur dikes necessarily cause a constriction, they may have important effects both downstream

15 Mar 91

and upstream possibly for considerable distances. Longitudinal dikes also cause a constriction if they are connected to shore at one or both ends.

a. The location, layout, and orientation of training dikes, as well as scour problems around the structure, can be determined best by use of a physical or numerical hydraulic model. Without the use of a model, there will be little assurance that a satisfactory design has been obtained until the structures have been built and their action observed. These structures are expensive, and it is necessary to have the best obtainable assurance that they will have the desired effects on the regimen of the waterway.

b. The clearance between the edge of the channel and the ends of spur dikes or a longitudinal dike must be adequate to assure safe navigation. Vessels get off course, particularly during low visibility, and they may suffer damage if they strike the dike. It is desirable to avoid locating dikes adjacent to curves or turns in the channel, as vessels are more likely to stray from the channel in negotiating the turn. It is important to keep in mind that the existing navigation channel may not be the ultimate configuration or depth; therefore, consideration should be given to so locating the dike to permit an improved channel to be excavated with the dike still at an adequate distance from its edge. Adequacy of clearance between the edge of the channel and training works varies from waterway to waterway and reach to reach. Channel design procedures for navigation safety are discussed in ER 1110-2-1404 and EM 1110-2-1613.

5-14. Revetments. Revetment of the banks of tidal waterways is usually necessary where the width is only slightly greater than the width of the navigation channel, and where wave wash due to passing vessels will cause erosion. If a bank needs protection from erosion by revetment, it is essential that the bank be reveted to as low a level as possible and that undercutting be prevented. Revetments are usually expensive to construct and require periodic maintenance. Design considerations for revetments are given in US Army Engineer Waterways Experiment Station (1984), McDowell and O'Connor (1977), Peterson (1986), and EM 1110-2-1601.

5-15. Diversion Works. Upland discharges of sediment-laden fresh water into the tidal waterway often results in heavy shoaling. Under favorable circumstances, it may be possible to divert the principal upland discharge from an estuary having important navigation channels that are subject to heavy shoaling into a nearby waterway where shoaling is inconsequential.

a. The water in the estuary from which the freshwater discharges are to be diverted will become more saline depending upon the fraction of fresh water removed. If the waters of the estuary are used for domestic, agricultural, or industrial purposes, the diversion will have serious effects on the local economy. It may be necessary to provide a substitute source of supply as part of the diversion scheme. As diversion may either improve or worsen water quality conditions in the waterway, the effect on water quality should be intensely studied. Similarly, the diversion will cause the waterway receiving the diversion to be less saline than before; it will accelerate the

currents, possibly causing scour of the bed and banks; and it may cause shoaling in downstream reaches. The decrease in salinity may be detrimental to a seafood industry, the sediment may damage nearby beaches, and the shoaling may be harmful to the existing navigation in the waterway receiving the diverted waters. Erosion of the banks in the receiving waterway may cause significant property damages.

b. The diversion works consist of a dam to close the estuary from normal and most flood discharges, and a canal to convey the diverted waters to a neighboring stream or to the sea. If the canal is of considerable length, it may be found to be infeasible to provide a cross section adequate to discharge floods greater than some magnitude to be defined by economic analyses. The factors in such economic analyses are the costs of diversion works required for flows of the several magnitudes being considered and the adverse effects of permitting flows larger than each of these to be discharged to sea through the estuary. Sediment transport capacity should also be considered in the design of the diversion channel.

5-16. Sediment Traps. The purpose of a sediment trap is to manage sedimentation processes so that sediment can be dredged in the most cost-effective manner. Properly designed traps allow for the removal of sediment at locations that result in the least overall maintenance dredging costs. The critical factor for trap effectiveness is that the material trapped would have otherwise deposited somewhere within the project boundaries. If a large percent of material trapped would otherwise be transported through the estuary or be deposited in areas outside the project limits, the trap is ineffective and should not be maintained as a sediment trap.

a. If a physical hydraulic model of the estuary is available, much of the trial and error involved in developing an effective trap can be done in the model in a few weeks rather than in the field over a period of years. In the past, WES has conducted sediment trap tests in physical models, such as those described in Dronkers-Schoenfeld (1955), Ippen and Harleman (1961), Johnson, Boyd, and Keulegan (1987), McDowell and O'Connor (1977), Peterson (1986), Trawle and Boland (1979), and USAED, San Francisco (1979).

b. Sediment traps can now be investigated with numerical sediment transport models, a modeling tool that has only recently become available. In a numerical modeling effort, the investigation of sediment traps can be part of an overall evaluation of shoaling under proposed conditions. An example of this type of investigation is given in Granat (1987).

c. The investigation of sediment traps in an estuary using either a physical model or a numerical sediment transport model is not inexpensive. However, these are the principal tools available to address the problem in a complex system such as a tidal estuary with a reasonable degree of confidence. The investment in models can be repaid by correction of costly design deficiencies or identification of more workable solutions.

#### Section IV. Maintenance Dredging

5-17. Dredging Plant. The selection of dredging plant and the operational procedures to be employed are based on the in situ characteristics of the materials to be removed, traffic conditions in the waterway, the distances to disposal areas, the exposure to waves that may disrupt operations or damage equipment, availability of dredging plant, and environmental considerations. Where there are alternatives, the selection should be determined on the basis of the least cost of producing the desired channel (not the lowest unit cost of dredging) with a method that is environmentally acceptable. The cost of proper disposal of the dredged material, to the end that the material once dredged cannot return to the shoal, should be considered. On the other hand, it is conceivable that some other method is competent to remove very large volumes of material at very low costs, and even if a large portion of the material returns to the shoal, the depths provided are obtained at lower annual cost than would be experienced if the dredged material were meticulously removed from the waterway. The choice should always be for the method that produces a satisfactory channel at the least annual cost and environmental damage; the cost per cubic yard dredged is not in itself always a complete basis for selection of plant and methods for dredging.

a. When the work is to be done by contract rather than by Government plant and labor, it is rarely possible to specify the kind of plant to be employed, but the specifications will provide for the end results desired, require that plant move aside for traffic, and specify rehandling and disposal requirements. In situations where careful disposal of the dredged material is necessary to obtain a satisfactory channel at the least cost, this will be required in the specifications regardless of whether the plant of some prospective bidders will have more difficulty complying with the specifications. Environmental requirements may restrict the use of certain dredging equipment at a specific project. The conditions at the disposal area may also restrict certain equipment, i.e., if settling rates are not adequate, disposal may be limited to mechanical methods.

b. If unconsolidated or weakly consolidated deposits are to be dredged, dipper, bucket, pipeline, hopper, or sidecasting dredges may be used. Where the deposits include boulders, it may be necessary to use dipper or bucket dredges unless the boulders can be buried by overdigging with the suction head or cutterhead close to the boulder and causing it to topple into the hole. For new-work dredging, as contrasted with maintenance dredging, consolidated sand or silt or clayey materials may be encountered. For dredging such materials, the pipeline dredge with cutterhead rather than a suction head type of dredge will generally remove the material more economically. In rock or other strongly consolidated materials, it may be necessary to employ dipper or bucket dredges, and drilling and blasting may be required. Where the material is such that any of the conventional dredges can remove it effectively, the choice between them will be based on traffic density, distance to disposal areas, depth of cut, and exposure to wave action. If traffic density is so great that operations will be interrupted to an extent that results in costs being increased beyond those of plants subject to less interference, the



latter will be selected. Similar considerations will govern selection of plant in locations where significant wave action is likely. Distance to acceptable disposal areas is a factor in the cost of operations for all types of dredges, but it is likely to be most significant for pipeline dredges. When the length of pipeline to reach a given disposal area results in costs that make dipper, bucket, or hopper dredges in conjunction with remaining operations more economic, the pipeline dredge no longer is the best tool for the operation. Where the depth of cut is small in relation to the plant capability, it is usually found that the controlling factor in the cost of dipper, bucket, or pipeline dredges is the time involved in advancing the dredge into the deposit rather than the effort to remove the material. Hopper and side-casting dredges can more effectively cope with thin cuts, and may be the most economic dredge type in these instances. For further information, EM 1110-2-5025 as well as Herbich (1975) and Huston (1970) should be consulted.

5-18. Advance Maintenance Dredging. A typical dredged channel with no provision for advance maintenance dredging is shown in Figure 5-9. The basic specifications for the dredged dimensions are the authorized or project

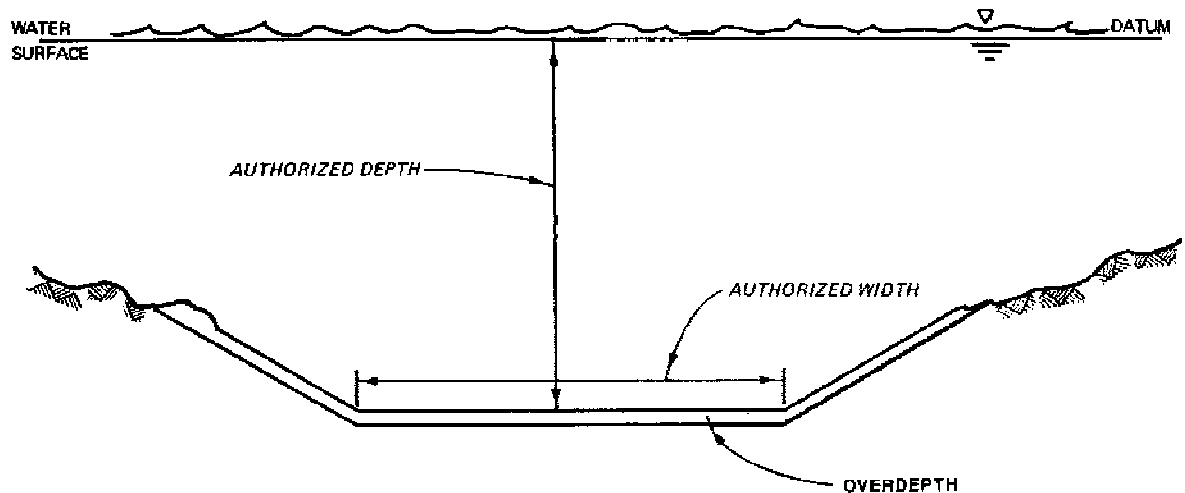

Figure 5-9. Typical dredged channel cross section without advance maintenance

depth, the authorized or project width, the side slopes, and the overdepth for providing channel dimensions project until the next dredging cycle. The authorized depths and widths are those channel dimensions authorized by Congress. If, for some reason, it becomes unnecessary to maintain a channel at authorized dimensions, the channel is maintained only to the economic dimensions, which are less than authorized.

a. A typical project with advance maintenance dredging included is shown in Figure 5-10. Typical amounts of advance maintenance vary from 1 to 10 feet. A listing of Corps projects using advance maintenance along with specifications is provided in Trawle and Boyd (1978). The primary objective

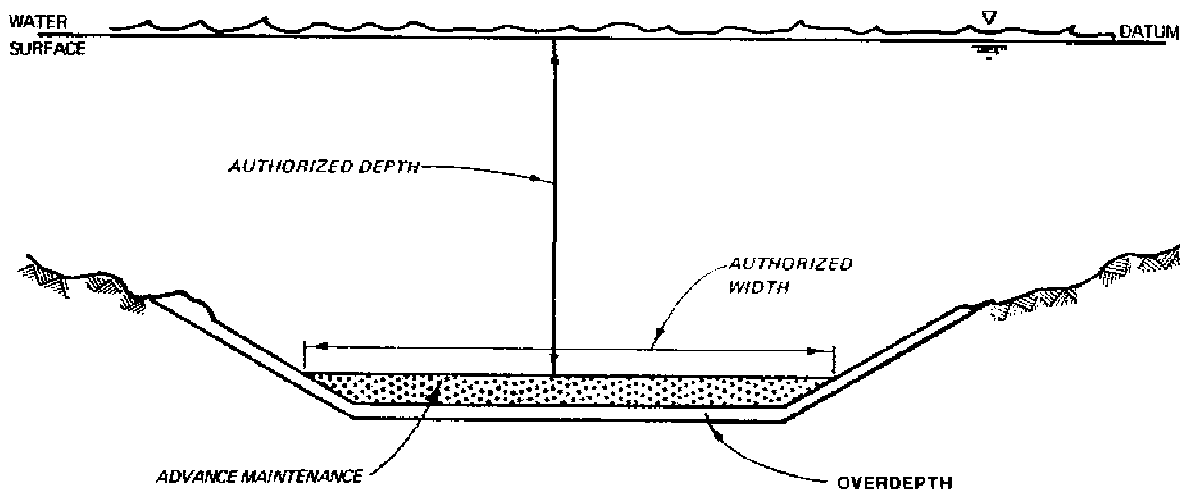

Figure 5-10. Typical channel cross sections with overdepth form of advance maintenance included

of advance maintenance dredging is to reduce the required dredging frequency, which can result in reduced overall maintenance dredging costs. A second objective can be to increase the percentage of time that a project is at project dimensions.

b. Advance maintenance dredging should not be confused with allowable dredging overdepth. The allowable dredging overdepth, usually 1 or 2 feet, is simply a margin for error that allows the dredging contractor to be paid for material dredged within a specified depth (usually 1 or 2 feet) below the required depth.

c. The key factor in advance maintenance effectiveness is the relation between depth and sedimentation rates. If increased depth causes no increase or only a slight increase in sedimentation rates, then advance maintenance can be very effective, since the required dredging frequency can be significantly reduced with little or no increase in overall maintenance dredging volumes. If, however, increased depth causes dramatic increases in the sedimentation rates, advance maintenance is probably not an effective technique, since the required dredging frequency will not be reduced significantly and overall maintenance dredging volumes can increase greatly. For more information on advance maintenance design considerations, see Trawle (1981), Berger and Boyd (1985), and Gelbert and Kean (1987).

5-19. Agitation Dredging. Agitation dredging is the removal of bottom material from a selected area by using equipment to suspend it temporarily in the water column and allowing currents to carry it away. This definition means that agitation of the bottom material is accomplished by some type of equipment and that the main purpose of the dredging equipment is to raise bottom material into the water column. Currents are used to move the material in the water column. Natural tidal currents are usually the mechanism for transport, although they may be augmented by currents generated by the agitation

equipment. Since currents are a necessary part of the agitation dredging process, a good understanding of local hydrodynamics is essential for a successful operation. If the material is suspended but shortly redeposits in the same area, only agitation (not agitation dredging) has occurred. By definition, agitation dredging includes transport of material away from the problem area. However, care should be taken to assure that the agitated material does not redeposit in nearby navigational facilities. Agitation dredging can be accomplished using a wide variety of equipment. Some of the equipment that has been applied in the field to perform agitation dredging will now be discussed.

a. Hopper Dredges. Hopper dredge agitation is produced by hopper overflow. The success of this type of agitation dredging hinges on two factors:

(1) The sediments should be of such character so that the hopper dredge can easily raise bottom materials to the surface.

(2) Currents should be sufficient to remove agitated material from the navigation channel. Detailed discussions on hopper dredge agitation dredging are given in Richardson (1984), USAED, Philadelphia (1969), and USAED, New Orleans (1973).

b. Propwash. Successful agitation dredging operations by propwash tend to have the following characteristics:

(1) The propwash vessel is fitted with an adjustable deflector device and convenient anchoring system.

(2) Shoaling is localized and well-defined in moderate water depths.

(3) Shoal material is fine, easily erodible, and uncompacted.

(4) Natural currents augment the agitation and transport process.

(5) Wave action is not severe enough to cause a hazard to the dredging plant or render the operation ineffective.

Detailed discussions on propwash agitation dredging are given in Richardson (1984), Slotta et al. (1974), Bechly (1975), and Burke and Wyal (1980).

5-20. Vertical Mixers and Air Bubblers. Vertical mixers such as the Helixor and Ventra Vac units and air bubblers are grouped together because they claim the same basic operating principle: by releasing compressed air near the bottom, the devices induce currents in the water column rising from the bottom to the surface. These currents are supposed to carry with them sediment from the bottom and near-bottom, at least part of which is to be resuspended by horizontal currents feeding the rising vertical currents.

15 Mar 91

a. In theory, such devices should work by maintaining sediment in suspension until natural currents can flush it away. In practice, however, no successful field results have been reported to date. There appear to be some fundamental problems with how the operating principle of such devices relates to the objective in agitation dredging.

b. There is no question that such devices as the Helixor, Ventra Vac, and air bubbleers can induce significant rising vertical currents extending to the water surface. In agitation dredging with these devices, however, the horizontal flow patterns and velocities are also important, since horizontal flow is what brings sediment to the vertical plume. Investigators have shown that horizontal currents into line source air bubbleers are relatively weak, the zone of influence of such currents is limited, and exponential power increases are required to increase horizontal flow into the bubble plume. A detailed discussion on the use of these devices in agitation dredging is Richardson (1984) and DeNekker and Knol (1968).

5-21. Rakes and Drag Beams. Rakes, drag beams, and similar devices work by being pulled over the bottom, mechanically loosening the bottom material and raising it slightly in the water column. Although crude, they can be effective in areas with cemented, cohesive, or consolidated sediments; and they require no special equipment other than a vessel to pull them. In shallower water and with a large enough vessel, propwash may help in the agitation process as well. The draghead of a trailing suction hopper dredge acts as a rake to some degree as it is pulled along the bottom, since not all of the material it loosens is drawn into the suction tube. Since rakes and drag beams produce no currents of their own and since they do not resuspend material as much as loosen it, they must be used in conjunction with natural currents strong enough to transport the loosened material away from the shoaling site. Drag beams have been used to displace material above required depth and move it into areas that have been overdredged. One possible way for helping the dragging process is by the use of air bubbleers. Another way would be to deflect the propwash of the towing vessel downward toward the dragging device. A combination of the three--dragging, air bubbler, and propwash--might prove the most effective of all, especially when the towing vessel moves into a current so maximum use is made of the propwash. A detailed discussion of agitation dredging using rakes and drag beams is given in Richardson (1984).

5-22. Water Jets. Water jets for agitation dredging operate on the same fundamental principle as propwash agitation with the following main differences:

- a. Water jets can be grouped in any arrangement desired.
- b. Streams issuing from the jets usually originate close to or on the bottom rather than the surface.
- c. Water jets are usually used in fixed locations.
- d. Water jets are usually intended for frequent operation to prevent

large shoaling accumulations, whereas propwash is a remedial measure to remove shoal deposits. Because of the last point mentioned, water jet installations lend themselves to automatic operation. They may also have difficulty removing larger amounts of shoaling that might accumulate during periods of non-operation. Detailed discussions on the use of water jets in agitation dredging are given in Richardson (1984), Ali and Halliwell (1980), and Barlard (1980).

#### Section V. Case Histories

5-23. Description. A case history that describes the hydraulic processes that occur in an estuary as well as provides the history of development of that estuary is an important item when modifications to any estuary are being considered. The case history should be developed early on as a guide for scoping future design studies. Such a document should include the discussion of any changes in hydraulic behavior observed as the result of past modifications by either man or nature. This document will provide valuable information that should be summarized in subsequent design documents.

5-24. Contents. Case histories should include the following information:

- a. History of project authorization and development.
- b. Description of existing projects.
- c. Project-related problems.
- d. Facts and data bearing on the problem.
- e. Description of modeling (physical or numerical) studies.
- f. Analysis of problems.
- g. Lessons learned.

5-25. Lessons Learned. A discussion of lessons learned from Corps navigation projects, developed by the Committee on Tidal Hydraulics (CTH), is given in Appendix E.

5-26. Physical Model Studies. A list of the various tidal hydraulic model investigations that have been constructed and operated by WES is given in Appendix F.

## CHAPTER 6

### ENVIRONMENTAL CONSIDERATIONS

#### 6-1. General.

a. Environmental Impacts. Estuarine modifications are usually intended to improve navigation conditions or provide for flood control. However, these modifications may have short- and long-term impacts on the environment at the site of the control work and both upstream and downstream of the control work. New-work dredging provides access to navigational facilities, and maintenance dredging sustains that access. Impacts of dredging on both water quality and shoaling should be considered. Some modifications are described as follows.

(1) Dredging. Deepening channels often causes increased salinity intrusion, and sedimentation rates and patterns may be changed. Biota in the channel area may be destroyed. Both new-work and maintenance dredging material must be disposed in an environmentally acceptable manner.

(2) Diversion works. Diversion works may cause the salinity in the estuary from which the fresh water is diverted to become essentially as saline as the ocean at the mouth. Also, the salinity in the waterway receiving the diverted flow will decrease. The currents will be accelerated, possibly causing scour of the bed and banks, and shoaling may become a problem in the downstream reaches of the water body receiving the diverted flow.

(3) Hurricane barriers. Hurricane barriers may accelerate shoaling both upstream and downstream and cause tides to rise higher and fall lower on the downstream side. While the tide range may be decreased upstream, the elevation of the mean water level may be increased.

(4) Salinity barriers. These barriers may cause tides to rise higher and fall lower downstream of the barrier, cause shoreline properties to be inundated to an extent, and decrease navigation depths at low tide. Shoaling may become more serious both upstream and downstream of the salinity barrier.

b. Reporting Requirements. Because of the possible environmental impacts, both new projects and operation and maintenance activities must be consistent with national environmental policies. In general, these policies require creation and maintenance of conditions under which human activities and natural environments can exist in productive harmony including preservation of historic and archeological resources. Corps project development is documented by a series of studies, each more specific than the previous one. The series of reports produced for a given type of project often evolves due to changing regulations. However, in general, the environmental impacts of the project must be included in all reports prepared prior to Congressional project authorization. (Refer to EM 1110-2-1202 for a description of this process.)

c. Statutes and Regulations. Compliance with Federal statutes, Executive guidelines, and Corps regulations often requires studies of existing environmental conditions and those likely to occur in the future with and without various activities. EM 1110-2-1202 lists the major environmental statutes and regulations that are currently applicable to Corps waterway projects. Four statutes that have a major impact on the planning and operation of projects in estuaries are the Estuary Protection Act, the National Environmental Policy Act, the Clean Water Act, and the Marine Protection, Research and Sanctuaries Act. There are also State and local regulations that must be satisfied.

(1) Estuary Protection Act. With this act Congress declared that many estuaries in the United States are rich in a variety of natural, commercial, and other resources, and it is declared to be the policy of Congress to recognize, preserve, and protect the responsibilities of the States in protecting, conserving, and restoring the estuaries in the United States.

(2) National Environmental Policy Act (NEPA). NEPA is the Federal statute that established national policy for the protection of the environment and set goals to be achieved along with the means to carry out these goals. This act requires preparation of an Environmental Impact Statement (EIS) for certain Federal actions affecting the environment in accordance with US Environmental Protection Agency (EPA) implementing regulations for NEPA. Environmental assessments (EA) are prepared for all other Corps actions that may not have a significant impact on the environment except for certain minor actions that are categorically excluded from NEPA review. Emergency activities do not require the preparation of an EIS.

(3) Clean Water Act. Section 404 of the Clean Water Act governs the discharge of dredged or fill material into waters of the United States. The evaluation of the effects of discharge of dredged or fill material should include consideration of the guidelines developed by EPA.

(4) Marine Protection, Research and Sanctuaries Act (MPRSA). The MPRSA governs the transport of dredged material for the purpose of ocean disposal. Title I of the MPRSA, which is the Act's primary regulatory section, authorizes the Secretary of the Army acting through the Corps (Section 103) to establish ocean disposal permit programs for dredged materials. In addition, Section 103(e) requires that Federal projects involving ocean disposal of dredged material shall meet the same requirements as developed for permits.

d. Environmental Study Management. At each stage of a project, efforts should be made to identify key environmental concerns and corresponding future information needs. Adequate forecasting of data needs is necessary to schedule adequate time for such activities as field data collection and physical or numerical modeling. Scheduling for work by others should allow for administrative procedures such as contractor selection, review procedures, and potential delays.

(1) Critical issues. Time and money constraints preclude detailed investigations and data collection for every area of interest; therefore, the most critical issues should be identified. It is essential that the number of factors assessed be adequate to fully account for all significant effects. The addition of other factors to be considered will increase the time, funds, and expertise required for the study. Therefore, a proper balance between adequate analysis and study resources must be achieved. Criteria for determining the importance of an issue include, but are not limited to, statutory requirements, Executive orders, agency policies and goals, and public interest. Federal regulations must be followed when determining the scope of an EIS.

(2) Environmental data. Environmental data collection is discussed in Paragraph 6-5. Well-defined, detailed objectives must be established prior to data collection. The design for the investigation should include a rationale for variable selection, sampling locations and frequencies, data storage and analysis, and hypotheses to be tested.

(a) Environmental studies during the preliminary stages of project development should emphasize identification of resources, development of an evaluation framework, and collection of readily available information for all potential alternatives. Resources likely to be impacted are evaluated, and further information needs are identified.

(b) Detailed analysis normally occurs after two or three specific alternatives have been selected for further study. The major emphasis of environmental studies in the detailed assessment stage should be directed toward identifying, describing, and appraising individual effects and evaluating the net effects of each alternative. Both positive and negative environmental effects should be characterized in adequate detail so they can be used along with the economic and technical analyses to compare alternatives.

#### 6-2. Water Quality Considerations.

a. General. The impacts of estuarine control works on water quality can be categorized as follows:

(1) Impacts from dredging and disposal during construction and maintenance.

(2) Altered circulation caused by changes in geometry.

(3) Increased pollutant loadings due to facility construction and accidental vessel discharges or spills.

(4) Salinity changes.

Industrial and municipal effluents and agricultural runoff with attendant problems of low dissolved oxygen (DO), eutrophication, or toxic contamination are not primary Corps concerns unless Corps activities have the potential to



mitigate or intensify already existing water quality problems. However, these conditions and the potential for water quality problems should be identified and documented in the early project stages.

b. Dredging and Disposal. The major water quality considerations of dredging and dredged material disposal are directly related to the amount of contaminants present and the mobility of the contaminant into environmental pathways by biological or hydrodynamic processes. The chemistry of contaminants in sediments is controlled primarily by the physicochemical conditions under which the sediment exists. Fine-grained sediments are typically anoxic, chemically reduced, and nearly neutral in pH. The effect of disposal environments on these chemical characteristics is an important consideration in the selection of disposal options. If sediment is disposed in an aquatic environment, sediment chemistry may not change. However, transfer of the sediment to a dryer environment, such as an upland disposal site, may change the chemistry to an anoxic and lower pH condition more favorable to the release of contaminants. Biological and physical processes may also affect the release of contaminants at a disposal site. Different contaminants and sediments with different properties do not always respond to an altered biological or physicochemical condition. This would mean that contaminant release would be a site-specific process and would be difficult to predict. Procedures are available for evaluating the environmental impacts of three major disposal alternatives: open water, intertidal, and upland methods (see Paragraph 6-4). Water quality considerations for dredging and disposal operations are summarized in the Dredged Material Research Program Synthesis of Research Results report series. An index of these reports is given in Herner and Company (1980). For detailed information on water quality considerations during dredging, refer to EM 1110-2-5025.

c. Altered Circulation.

(1) Circulation may be altered as a result of modifications to an estuary, its tributaries, or its sea connection. Changes in circulation may result in changes in the spatial distribution of water quality constituents, in the flushing rates of contaminants, and in the pattern of scour and deposition of sediments.

(2) Environmental assessment of the effects of changes in circulation should initially emphasize the physical parameters such as salinity, temperature, and velocity and their impacts on plant and animal communities. These initial analyses should consider changes in vertical stratification when deepening of a channel is proposed. Increased density stratification inhibits vertical mixing, which may result in depletion of DO in bottom waters. If minimal changes occur in these parameters, then it can be generally assumed that the chemical characteristics of the system will not change significantly. This approach is based on a methodology that permits assessment without requiring extensive data and knowledge of the processes affecting the water quality constituent of direct interest. However, this approach is invalid if preliminary water quality surveys indicate the existence of toxic constituents at concentrations potentially damaging to biotic populations. Prediction of

change in circulation and its effect on the physical parameters can be achieved through comparison with existing projects, physical model studies, and numerical simulation.

d. Pollutant Loadings. Increased pollutant loadings may result from facility construction, vessel discharges, and accidental spills. Increased navigational traffic as a result of estuarine modifications may also increase contaminant release through either accidental spillage of toxic cargoes, vessel discharges, or short-term alterations in ambient estuarine hydraulic conditions (propagation of waves, generation of currents, drawdown, and pressure and velocity changes) that may resuspend bottom sediments. Resuspended bottom sediments temporarily increase turbidity and total suspended solids concentrations. Generally, photosynthesis does not decrease and may even increase because of the release of nutrients from suspended fine sediments. Resuspension of fine sediments may decrease DO by increasing oxygen demand. The additive effect of increased navigation traffic may be to maintain high levels of solids and turbidity, which could have a permanent effect on the estuarine water quality. Also modifications may result in increased industrial development, which may result in industrial effluents, spills, and contaminated surface runoff entering the estuary. All of these factors should be considered when determining the possible increase in pollutant loadings and the impact it may have on the estuarine water quality.

e. Salinity Changes. Changes in salinity may result from the construction of estuarine control works or channel deepening. Construction and operation of locks may cause salinity intrusion in upstream portions of estuaries normally used for freshwater supplies. Also, diversion works may cause normally freshwater portions of an estuary to become saline or vice versa. If these freshwater supplies are used for municipal, agricultural, or industrial purposes, then the prevention of salinity intrusion can be a controlling factor in designing the estuarine control work project. Estuarine ecological features may also be influenced by a reduction in salinity as a result of barriers or diversion structures. The decrease in salinity may be detrimental to a seafood industry, affecting such estuarine ecological features as oyster beds or fish and shrimp nurseries. Consideration should be given to both short- and long-term changes in salinity during all seasons of the year, as these changes can have a drastic effect on sensitive ecological features.

### 6-3. Biological Considerations.

a. General. The effects of estuarine modifications on plants and animals may result from the physical changes in habitat due to the enlargement of channels, disposal of dredged material, and the construction of various control works. Other effects may result from changes in contaminant levels, turbidity, suspended sediments, salinity, circulation, and erosion. Preliminary research suggests that navigation traffic itself affects certain species. Weather and large storm events, such as hurricanes on the Gulf Coast, can devastate an estuary in a short period of time. These effects on habitat in the estuary may be short- and long-term physical changes.

b. Reference. This and other considerations have already been addressed in EM 1110-2-1202. It should also be noted that the EM contains a glossary of the scientific terms, some of which are used in this EM.

6-4. Dredging Effects Considerations.

a. General. Dredging is a major activity in the development or improvement of navigation and flood-control projects in estuaries. During the design phase of such projects, the environmental effects associated with dredging and dredged material disposal must be considered. The primary short-term objective of a dredging project is to provide authorized project dimensions. This should be accomplished using the most technically satisfactory, environmentally compatible, and economically feasible dredging and dredged material disposal procedures. Long-term dredging objectives concern the efficient management and operation of dredging and disposal activities during continued operation and maintenance of the project. The environmental considerations required to support the design of new-work or maintenance dredging projects are outlined in the following paragraph.

b. Basic Considerations. In order to consider the environmental aspects of dredging and dredged material disposal in the design phase of a project, the activities listed in Table 6-1 are required. Although dredging and related matters have traditionally been considered an operations and maintenance function, a well-coordinated approach in the planning and design stages can minimize problems in the operations and maintenance of the project. This is especially true regarding long-range planning for disposal of both new-work and maintenance dredged material. For a more complete discussion, along with disposal alternatives, habitat development, and associated uses (such as recreation and aesthetics, etc.) refer to EM 1110-2-1202 and EM 1110-2-5026.

6-5. Environmental Data Collection and Analysis. In the process of planning and designing estuarine navigation projects, potential environmental impacts must be assessed. This is done through very detailed and site-specific data collection efforts. However, some basic requirements are common to all data collection programs.

6-6. Mitigation Decision Analysis.

a. Policy. Care must be taken to preserve and protect environmental resources, including unique and important ecological, aesthetic, and cultural values. The Fish and Wildlife Coordination Act of 1958 (PL 85-624, 16 U.S.C. 61, et seq.) requires fish and wildlife mitigation measures when justified. Specific mitigation policy for significant fish and wildlife and historic and archeological resources is included in ER 1105-2-50, Chapters 2 and 3. Damage from Federal navigation work along the shorelines of the United States must be prevented or mitigated.

TABLE 6-1  
Basic Considerations

<u>Step</u>	<u>Information Source</u>
Analyze dredging location and quantities to be dredged	Hydrographic surveys, project maps
Determine the physical and chemical characteristics of the sediments	WES TR DS-78-10 (Section 6-8) (Palermo, Montgomery, and Poindexter 1978)
Determine whether or not there will be dredging of contaminated sediments	WES TR DS-78-6 (Brannon 1978)
Evaluate disposal alternatives	EM 1110-2-5025
Select the proper dredge plant for a given project	EM 1110-2-5025
Determine the levels of suspended solids from dredging and disposal operations	WES TR DS-78-13 (Barnard 1978)
Control the dredging operation to ensure environmental protection	WES TR DS-78-13 (Barnard 1978)
Identify pertinent social, environmental, and institutional factors	Paragraph 6-1
Evaluate dredging and disposal impacts	WES TR DS-78-1 (Wright 1978); WES TR DS-78-5 (Hirsch, Di Salvo, and Peddicord 1978)

b. Types of Mitigation. Based on the Council on Environmental Quality (CEQ) definition, mitigation includes:

(1) Avoiding the impact altogether by not taking a certain action or parts of an action.

(2) Minimizing impacts by limiting the degree of magnitude of the action and its implementation.

(3) Rectifying the impact by repairing, rehabilitating, or restoring the affected environment.

(4) Reducing or eliminating the impact over time by preservation and maintenance operations during the life of the action.

(5) Compensating for the impact by replacing or providing substitute resources or environments.

c. Justification for Mitigation. Justification of mitigation measures shall be based on the significance of the resource losses due to a plan, compared to the costs necessary to carry out the mitigation (ER 1105-2-50, 2-4C.1). Extent of mitigation justified will ultimately be determined through negotiation with the US Fish and Wildlife Service and the concerned state. Endangered and threatened species and critical habitats will be given special consideration.

d. Resources Impacted. Impacts from dredged material disposal and hydraulic changes affect primarily shorelines, wetlands, vegetated shallows, and riparian zones. These areas will usually be composed of or considered to be significant resources. Appendix C of ER 1105-2-50 (Subparts C-F) describes potential impacts on these resources.

e. Key Concepts for Mitigation.

(1) Early Participation. To determine significant resource losses that will occur because of a project, environmental personnel must be involved in the project from the beginning. Once such potential losses are identified, the project can be modified to reduce or eliminate them. If modification is inadequate or infeasible, measures to offset the losses should be developed. Through early participation, the definition of mitigation can serve as a sequence of steps to follow.

(2) Long-term planning. Hershman and Ruotsala (1978) suggest building mitigation into a long-term estuary management plan, such that development and environmental protection proceed simultaneously. This approach allows cumulative impacts to be mitigated, decreases time and cost per project, and spreads the mitigation burden more equitably.

(3) Mitigation planning goals. Four options for mitigation efforts are summarized as follows:

(a) In-kind: resources physically, biologically, and functionally similar to those being altered.

(b) Out-of-kind: resources as above, dissimilar.

(c) Onsite: occurring on, adjacent to, or in the immediate proximity of the project site.

(d) Offsite: occurring at a point away from the project site.

A guide to selecting any combination of (a) or (b) and (c) or (d) as a mitigation option is found in US Fish and Wildlife Service (1980) in which resource categories, attendant mitigation goals, and mitigation measures are suggested.

6-7. Checklist of Environmental Studies.

a. The following checklist consists of some of the environmental factors that should be considered for estuarine navigation projects. This checklist is cumulative, and not all studies are appropriate for all projects.

(1) Characterization of existing conditions at project site.

(2) Estimation of construction activities by others likely to be associated with Federal project.

(3) Evaluation of project effects on circulation patterns and stage variations.

(4) Evaluation of project effects on water quality.

(5) Characterization and testing of sediments to be dredged (Section 404 or 103 evaluation as appropriate).

(6) Analysis of dredging alternatives (dredge plant, timing, etc.).

(7) Analysis of disposal alternatives.

(8) Evaluation of project effects on sedimentation rates and shoaling locations.

(9) Analysis of effects of winter navigation if ice coverage will occur.

(10) Evaluation of aesthetic, cultural, and recreational aspects.

(11) Coordination with other agencies, the public, and private groups.

(12) Planning and design of monitoring programs.

b. For a more complete discussion of this checklist, refer to EM 1110-2-1202.

## APPENDIX A

## BIBLIOGRAPHY

- Abbot, M. B. 1979. Computational Hydraulics, Theory of Free Surface Flows, Fearon-Pitman Publishers, Inc., Belmont, CA.
- Ables, J. H. 1978. "Filling and Emptying System, New Ship Lock, Mississippi River-Gulf Outlet, Louisiana; Hydraulic Model Investigation," Technical Report H-78-16, US Army Engineer Waterways Experiment Station, Vicksburg, MS.
- Abraham, G., and Burgh, P. V. D. 1964 (Jan). "Pneumatic Reduction of Salt Intrusion Through Locks," Journal of the Hydraulics Division, ASCE, Vol 90, HY-1, pp 83-119.
- Ackers, P. 1972. "Sediment Transport in Channels, An Alternative Approach," HRS Int. Report 102, Hydraulics Research Station, Wallingord, England.
- Ali, K. H. M., and Halliwell, A. R. 1980. "The Use of Water-Jets for Scouring and Dredging," Proceedings, Third International Symposium on Dredging Technology, BHRA, pp 239-265.
- American Society for Testing and Materials. 1964 (Dec). Procedures for Testing Soils, ASTM Committee D-18 on Soils and Rocks for Engineering Purposes, 4th ed., Philadelphia, PA.
- Ariathurai, R., and Krone, R. B. 1976. "Mathematical Modeling of Sediment Transport in Estuaries," Estuarine Processes, Vol II, M. Wiley, ed., Academic Press, New York, pp 98-106.
- Ariathurai, R., and Arulanandan, K. 1978 (Feb). "Erosion Rates of Cohesive Soils," Journal of the Hydraulics Division, ASCE, Vol 104, No. HY2, pp 279-283.
- Bagnold, R. A. 1966. "An Approach to the Sediment Transport Problem from General Physics," Professional Paper No. 422-J, US Geological Survey.
- Barlard, J. A. 1980. "A Design Procedure for Scour Jet Arrays," Proceedings, Dredging and Sedimentation Control, 1980, Naval Facilities Engineering Command and Office of Naval Research, Washington, DC.
- Barnard, W. D. 1978 (Aug). "Prediction and Control of Dredged Material Dispersion Around Dredging and Open-Water Pipeline Disposal Operations," Technical Report DS-78-13, US Army Engineer Waterways Experiment Station, Vicksburg, MS.
- Bascom, W. 1980. Waves and Beaches, The Dynamics of the Ocean Surface (Revised and Updated), Anchor Press/Doubleday, Garden City, NY.

EM 1110-2-1607  
15 Mar 91

Bechly, J. 1975 (Sep). "Sandwich Gives Nature a Boost on Shoal Removal," World Dredging and Marine Construction, Vol II, No. 10, pp 37-41.

Berger, R. C., and Boyd, J. A. 1985 (Apr). "Effects of Depth on Dredging Frequency; Report 3, Evaluation of Selected Projects," Technical Report H-78-5, US Army Engineer Waterways Experiment Station, Vicksburg, MS.

Brannon, J. M. 1978 (Aug). "Evaluation of Dredged Material Pollution Potential," Technical Report DS-78-6, US Army Engineer Waterways Experiment Station, Vicksburg, MS.

Bruun, P. 1978. Stability of Tidal Inlets, Theory and Engineering, Elsevier, Amsterdam.

Burke, T. D., and Wyal, C. E. 1980. "Using Propwash for Channel Maintenance Dredging," Proceedings, World Dredging Conference, WODCON IX, pp G09-G20.

Burt, T. N., and Stevenson, J. R. 1983 (Aug). "Field Settling Velocity of Thames Mud," Report IT 25I, Hydraulic Research, Wallingford, England.

Calcutta Port Commissioners. 1973. "The Study of the Hooghly Estuary and the Project for Training Measures below Diamond Harbour," Report, Hydraulic Study Department, Calcutta, India.

Cameron, W. M., and Pritchard, D. W. 1963. "Estuaries," The Sea, M. N. Hill, ed., Vol 2, Wiley, NY, pp 306-324.

Cargill, Kenneth W. 1983. "Procedures for Prediction of Consolidation in Soft Fine-Grained Dredged Material," Technical Report D-83-1, US Army Engineer Waterways Experiment Station, Vicksburg, MS.

Cargill, Kenneth W. 1985 (Jul). "Mathematical Model of the Consolidation/Desiccation Processes in Dredged Material," Technical Report D-85-4, US Army Engineer Waterways Experiment Station, Vicksburg, MS.

Channon, R. D. 1971 (Sep). "The Bristol Fall Column for Coarse Sediment Grading," Journal of Sedimentary Petrology, pp 167-870.

Committee on Tidal Hydraulics, Corps of Engineers, US Army. 1963. "Salt Water Intrusion, Lake Washington Ship Canal, Seattle, Washington," US Army Engineer Waterways Experiment Station, Vicksburg, MS.

Darwin, G. H. 1962. The Tides and Kindred Phenomena in the Solar System, W. H. Freeman and Company, San Francisco, CA.

Defant, A. 1958. Ebb and Flow, The Tides of Earth, Air, Water, University of Michigan Press, Ann Arbor, MI.



- DeNekker, J., and Knol, J. 1968. "Results of Experiments with an Air-Bubble Screen Against Siltation in the Rotterdam Harbour," Proceedings, 5th International Harbor Congress, Section 2, Paper DEN-KN.
- Dronkers-Schoenfeld. 1955. "Tidal Computations in Shallow Water," Proceedings, ASCE, Vol 81, Separate 714.
- Dyer, K. R. 1973. Estuaries, A Physical Introduction, Wiley, London.
- Fischer, H. B., et al, 1979. Mixing in Inland and Coastal Waters, Academic Press, NY.
- Gelbert, J. A., and Kean, T. L. 1987 (May). "Advance Maintenance Dredging Study for the Chesapeake and Delaware Canal and Approaches," Proceedings, Coastal Sediments '87 Symposium, ASCE, New York.
- Gibbs, R. J. 1977 (Mar). "Clay Mineral Segregation in the Marine Environment," Journal of Sedimentary Petrology, Vol 47, No. 1, pp 237-243.
- Granat, M. A. 1987. "Application of the TABS-2 Numerical Modeling System for the Evaluation of Advance Maintenance Dredging," Proceedings, San Francisco District Navigation Workshop, 18-21 May 87, pp 238-267. US Army Engineer District, San Francisco, San Francisco, CA.
- Grim, R. E. 1968. Clay Mineralogy, McGraw-Hill, New York.
- Hansen, D. V., and Rattray, M. Jr. 1966. "New Dimensions in Estuary Classification," Limnol Oceanog., 11, pp 319-326.
- Hauck, L. M. 1989 (Nov). "Sedimentation Analysis of the Proposed San Rafael Canal Tidal Barrier, San Rafael, California," Technical Report HL-89-24, US Army Engineer Waterways Experiment Station, Vicksburg, Miss.
- Hayter, E. J. 1983. "Prediction of Cohesive Sediment Transport in Estuarial Waters," Ph. D. Dissertation, University of Florida, Gainesville, FL.
- Hayter, E. J., and Mehta, A. J. 1984 (Sep). "Modeling Estuarial Cohesive Sediment Transport," Proceedings of the 19th Coastal Engineering Conference, ASCE, Vol III, Houston, TX, pp 2985-3000.
- Herbich, J. B. 1975. Coastal and Deep Ocean Dredging, Gulf Publishing, Houston, TX.
- Herner and Company. 1980 (Apr). "Publication Index and Retrieval System," Technical Report DS-78-23, US Army Engineer Waterways Experiment Station, Vicksburg, Miss.; prepared for Office, Chief of Engineers, US Army, Washington, DC, under Contract No. DACW39-77-C-0081.

EM 1110-2-1607  
15 Mar 91

Hershman, M. J., and Ruotsala, A. A. 1978 (Mar). "Implementing Environmental Mitigation Policies," Coastal Zone '78, San Francisco, CA, Vol II, pp 1333-1345, American Society of Civil Engineers, New York.

Hewlett, J. C., Daggett, L. L., and Heltzel, S. B. 1987 (Apr). "Ship Navigation Simulator Study; Savannah Harbor Widening Project, Savannah, Georgia," Technical Report HL-87-5, US Army Engineer Waterways Experiment Station, Vicksburg, MS.

Hirsch, N. D., DiSalvo, L. H., and Peddicord, Richard. 1978 (Aug). "Effects of Dredging and Disposal on Aquatic Organisms," Technical Report DS-78-5, US Army Engineer Waterways Experiment Station, Vicksburg, MS.

Hopkinson, C. S., Jr., and Hoffman, F. A. 1983. "The Estuary Extended - A Recipient-System Study of Estuarine Outwelling in Georgia," The Estuary as a Filter, V. S. Kennedy, ed., Academic Press, Orlando, Fl., pp 313-327.

Hunt, J. R. 1980. "Prediction of Oceanic Particle Size Distribution from Coagulation and Sedimentation Mechanisms," Advances in Chemistry Series No. 189 - Particle in Water, M. D. Kavanaugh and J. T. Keki, ed., American Chemical Society, pp 243-257.

Hunt, S. D. 1981. "A Comparative Review of Laboratory Data on Erosion of Cohesive Sediment Beds," UFL/COEL/MP - 81/7, Coastal and Oceanographic Engineering Dept, University of Florida, Gainesville, FL.

Huston, J. 1970. Hydraulic Dredging, Cornell Maritime Press, Cambridge, MD.

Huval, C., Comes, B., and Garner, R. T, III. 1985 (Jun). "Ship Simulation Study of John F. Baldwin (Phase II) Navigation Channel, San Francisco Bay, California," Technical Report HL-85-4, US Army Engineer Waterways Experiment Station, Vicksburg, Miss.

Huval, C. 1985 (Oct). "Ship Navigation Simulator Study, Upper Mobile Bay Channel," Miscellaneous Report HL-85-7, US Army Engineer Waterways Experiment Station, Vicksburg, Miss.

Inglis, C. C., and Allen, F. H. 1957. "The Regimen of the Thames Estuary as Affected by Currents, Salinities, and River Flow," Proceedings, Institution of Civil Engineering, pp 827-878.

Ippen, A. T., ed. 1966. Estuary and Coastline Hydrodynamics, McGraw-Hill, New York.

Ippen, A. T., and Harleman, D. R. F. 1961 (Jun). "One-Dimensional Analysis of Salinity Intrusion in Estuaries," "Technical Bulletin No. 5, Committee on Tidal Hydraulics, Corps of Engineers, US Army; prepared by US Army Engineer Waterways Experiment Station, Vicksburg, MS.

Jackson, M. L. 1958. Soil Chemical Analysis, Prentice-Hall, Englewood Cliffs, NJ.

Johnson, B. H., Boyd, M. B., and Keulegan, G. 1987 (Apr). "A Mathematical Study of the Impact on Salinity Intrusion of Deepening the Lower Mississippi River Navigation Channel," Technical Report TR-87-1, US Army Engineer Waterways Experiment Station, Vicksburg, MS.

Johnson, B. H., Trawle, M. J., and Kee, P. J. 1989 (Dec). "A Numerical Model Study of the Effect of Channel Deepening on Shoaling and Salinity Intrusion in the Savannah Estuary," Technical Report HL-89-26, US Army Engineer Waterways Experiment Station, Vicksburg, MS.

Kirby, R. 1969. "Sedimentary Environments, Sedimentary Processes and River History in the Lower Medway Estuary, Kent," Ph. D. Dissertation, University of London, United Kingdom.

Kranck, K. 1979. "Dynamics and Distribution of Suspended Particulate Matter in the St. Lawrence Estuary," Naturaliste Can., Vol 106, pp 163-173.

Krone, R. B. 1962. "Flume Studies of the Transport of Sediment in Estuarial Shoaling Processes," Final Report, Hydraulic Engineering Laboratory and Sanitary Engineering Research Laboratory, Berkeley, CA; prepared for US Army Engineer District, San Francisco, San Francisco, CA, under US Army Contract No. DA-04-203 CIVENG-59-2.

Krone, R. B. 1963 (Sep). "A Study of Rheological Properties of Estuarial Sediments," Technical Bulletin No. 7, Committee on Tidal Hydraulics, Corps of Engineers, US Army; prepared by US Army Engineer Waterways Experiment Station, Vicksburg, MS.

Krone, R. B. 1972 (Jun). "A Field Study of Flocculation as a Factor in Estuarial Shoaling Processes," Technical Bulletin No. 19, Committee on Tidal Hydraulics, Corps of Engineers, US Army; prepared by US Army Engineer Waterways Experiment Station, Vicksburg, MS.

Krone, R. B. 1979. "Sedimentation in the San Francisco Bay System," San Francisco Bay: The Urbanized Estuary, American Association for the Advancement of Science, Pacific Division, California Academy of Sciences, San Francisco, CA.

Krone, R. B. 1983 (Aug). "Cohesive Sediment Properties and Transport Parameters," Proceedings of the Conference on Frontiers in Hydraulic Engineering, ASCE, Cambridge, MA., pp 66-78.

Lane, E. W. 1955. "Design of Stable Channels," Transactions, ASCE, Vol 120, Paper No. 2776, pp 1234-1279.

Lauff, G. H. 1967. Estuaries, Publication 83, American Association for the Advancement of Science, California Academy of Sciences, San Francisco, CA.

EM 1110-2-1607  
15 Mar 91

Lunz, J. D., Clarke, D. G., and Fredette, T. J. 1984. "Seasonal Restrictions on Bucket Dredging Operations, A Critical Analysis with Recommendations," Proceedings of Dredging '84, ASCE Specialty Conference on Dredging and Dredged Material Disposal, Clearwater, FL.

Marmer, H. A. 1926. The Tide, D. Appleton and Co., New York.

McAnally, W. H., Jr., Brogdon, N. J., Jr., Letter, J. V., Jr., Stewart, J. P., and Thomas, W. A. 1983 (Sep). "Columbia River Estuary Hybrid Model Studies; Report 1, Verification of Hybrid Modeling of the Columbia River Mouth," Technical Report HL-83-16, US Army Engineer Waterways Experiment Station, Vicksburg, MS.

McDowell, D. M., and O'Connor, B. A. 1977. "The Study of Tidal Systems: Hydraulic Measurements," Hydraulic Behaviour of Estuaries, Wiley, New York, Chapter 5, pp 124-145.

Mehta, A. J., and Christensen, B. A. 1983. "Initiation of Sand Transport over Coarse Beds in Tidal Entrances," Coastal Engineering, Vol 7, pp 61-75.

Mehta, A. J., and Jones, C. P. 1977 (May). "Matanzas Inlet; Glossary of Inlets Report No. 5," Florida Sea Grant Program Report No. 21, Gainesville, FL.

Mehta, A. J., and Joshi, P. B. 1984 (Dec). "Review of Tidal Inlet Hydraulics," UFL/COEL-TR/054, Coastal and Oceanographic Engineering Department, University of Florida, Gainesville, FL.

Mehta, A. J., and Partheniades, E. 1975. "An Investigation of the Depositional Properties of Flocculated Fine Sediments," Journal of Hydraulic Research, Vol 13, No. 4, pp 361-381.

Mehta, A. J., Parchure, T. M., Dixit, J. G., and Auiathurai, R. 1982. "Resuspension Potential of Deposited Cohesive Sediment Beds," Estuarine Comparisone, V. S. Kennedy, ed., Academic Press, New York, pp 591-609.

Migniot, C. 1968. "A Study of the Physical Properties of Different Very Fine Sediments and Their Behavior under Hydrodynamic Action," La Houille Blanche, No. 7, pp 591-620 (in French with English abstract).

Montgomery, R. L. 1978 (Dec). "Methodology for Design of Fine-Grained Dredged Material Containment Areas for Solids Retention," Technical Report D-78-56, US Army Engineer Waterways Experiment Station, Vicksburg, MS.

O'Brien, M. P. 1969 (Feb). "Equilibrium Flow Areas of Inlets on Sandy Coasts," Journal of the Waterways and Harbors Division, ASCE, Vol 95, No. WW1, pp 43-52.

- O'Connor, B. A, and Tuxford, C. 1980. "Modelling Siltation at Dock Entrances," Proceedings of the Third International Symposium on Dredging Technology, BHRA, Paper - F2, pp 359-371, Bordeaux, France.
- Officer, C. B. 1976. Physical Oceanography of Estuaries (and Associated Coastal Waters), Wiley, New York.
- Owen, M. W. 1970 (Sep). "A Detailed Study of the Settling Velocities of an Estuary Mud," Report No. INT 78, Hydraulics Research Station, Wallingford, England.
- Owen, M. W. 1971 (Aug). "The Effect of Turbulence on the Settling Velocities of Silt Floccs," Proceedings of the 14th Congress of I.A.H.R., Vol 4, Paris, pp 27-32.
- Owen, M. W. 1973 (Dec). "Determination of the Settling Velocities of Cohesive Muds," Report No. IT 161, Hydraulics Research Station, Wallingford, England.
- Palermo, M. R., Montgomery, R. L., and Poindexter, M. E. 1978 (Dec). "Guidelines for Designing, Operating, and Managing Dredged Material Containment Areas," Technical Report DS-78-10, US Army Engineer Waterways Experiment Station, Vicksburg MS.
- Parchure, T. M. 1984. "Erosional Behavior of Deposited Cohesive Sediments," Ph. D. Dissertation, University of Florida, Gainesville, FL.
- Parker, W. R., and Kirby, R. 1982. "Time Dependent Properties of Cohesive Sediment in Relevant to Sedimentation Management, A European Experience," Estuarine Comparisons, V. S. Kennedy, ed., Academic Press, New York, pp 573-590.
- Partheniades, E. 1966. "Field Investigations to Determine Sediment Sources and Salinity Intrusion in the Maracaibo Estuary, Venezuela," Report No. 94, MIT, Hydrodynamics Lab, Cambridge, MA.
- Partheniades, E. 1977 (Sep). "Unified View of Wash Load and Bed Material Load and Bed Material Load," Journal of the Hydraulics Division, ASCE, Vol 103, No. HY9, pp 1037-1057.
- Peterson, M. S. 1986. River Engineering, Prentice-Hall, Englewood, NJ.
- Pritchard, D. W. 1952a. "Estuaries Hydrography," Advances in Geophysics, Vol 1, pp 243-280.
- Pritchard, D. W. 1952b. "Salinity Distribution and Circulation in the Chesapeake Bay Estuaries System," Journal, Marine Research, Vol 11, pp 106-123.
- Pritchard, D. W. 1955. "Estuaries Circulation Patterns," Proceedings, American Society of Civil Engineers, Vol 81, No. 717.

EM 1110-2-1607  
15 Mar 91

Richardson, T. W. 1984 (Jul). "Agitation Dredging: Lessons and Guidelines from Past Projects," Technical Report HL-84-6, US Army Engineer Waterways Experiment Station, Vicksburg, MS.

Schultz, E. A., and H. B. Simmons. 1957 (Apr). "Fresh Water-Salt Density Currents, A Major Cause of Siltation in Estuaries," Technical Bulletin No. 2, Committee on Tidal Hydraulics, Corps of Engineers, US Army; prepared by US Army Engineer Waterways Experiment Station, Vicksburg, MS.

Schureman, P. 1940. Manual of Harmonic Analysis and Prediction of Tides, Special Publication No. 98 (Revised 1940; reprinted 1958 with corrections) US Coast and Geodetic Survey, US Government Printing Office, Washington, DC.

Shields, A. 1936. "Application of Similarity Principles and Turbulence Research to Bed Load Movement," Mitteil. Preuss. Versuchsanstalt fur Wasserbau und Schiffbau, Berlin.

Silvester, R. 1974. Coastal Engineering, 2; Sedimentation, Estuaries, Tides, Effluents, and Modelling, Elsevier, New York.

Simmons, H. B. 1955. "Some Effects of Upland Discharges on Estuarine Hydraulics," Proceedings, American Society of Civil Engineers., Vol 81, No. 792.

Slotta, L. S., et al. 1974. "Effects of Shoal Removal by Propeller Wash, December 1973, Tillamook Bay Oregon," Contract No. 57-74-C-0087, Oregon State University, Corvallis, OR.

Terzaghi, K., and Peck, R. B. 1966. Soil Mechanics in Engineering Practice, 2nd ed., Wiley, New York.

Teeter, A. M. 1987 (May). "Alcatraz Disposal Site Investigation; Report 3, San Francisco Bay-Alcatraz Disposal Site Erodibility," Miscellaneous Paper HL-86-1, US Army Engineer Waterways Experiment Station, Vicksburg, Miss.

Teeter, A. M. 1988 (Dec). "New Bedford Harbor Superfund Project, Acushnet River Estuary Engineering Feasibility Study of Dredging and Dredged Material Disposal Alternatives; Report 2, Sediment and Contaminant Hydraulic Transport Investigations," Technical Report EL-88-15, US Army Engineer Waterways Experiment Station, Vicksburg, Miss.

Teeter, A. M. 1989 (Feb). "Effects of Cooper River Rediversion Flows on Shoaling Conditions at Charleston Harbor, Charleston, South Carolina," Technical Report HL-89-3, US Army Engineer Waterways Experiment Station, Vicksburg, Miss.

Teeter, A. M., and Pankow, W. 1989a (Sept). "The Atchafalaya River Delta; Report 2, Field Data, Section 2: Settling Characteristics of Bay Sediments," Technical Report HL-82-15, US Army Engineer Waterways Experiment Station, Vicksburg, Miss.

Teeter, A. M., and Pankow, W. 1989c (Sept). "Schematic Numerical Modeling of Harbor Deepening Effects on Sedimentation, Charleston, South Carolina," Miscellaneous Paper HL-89-7, US Army Engineer Waterways Experiment Station, Vicksburg, Miss.

Teeter, A., Hodges, S., and Coleman, C. 1987 (Sept). "Fine-Grained Sediments, An Annotated Bibliography on Their Dynamic Behavior in Aquatic Systems," Technical Report HL-87-6, US Army Engineer Waterways Experiment Station, Vicksburg, Miss.

Thomas, W. A., and McAnally, W. H. 1985 (Aug). "User's Manual for the Generalized Computer Program System: Open-Channel Flow and Sedimentation, TABS-2, Main Text and Appendices A Through O," Instruction Report HL-85-1, US Army Engineer Waterways Experiment Station, Vicksburg, MS.

Thorn, M. F. C., and Parsons, J. G. 1980 (Mar). "Erosion of Cohesive Sediments in Estuaries: An Engineering Guide," Proceedings of the Third International Symposium on Dredging Technology, BHRA, Paper F1, Bordeaux, France, pp 349-358.

Trawle, M. J. 1981 (Jul). "Effects of Depth on Dredging Frequency; Report 2, Methods of Estuaries Shoaling Analysis," Technical Report H-78-5, US Army Engineer Waterways Experiment Station, Vicksburg, MS.

Trawle, M. J., and Boland, R. A. 1979. "Georgetown Harbor, South Carolina; Report 2, Effects of Various Channel Schemes on Tides, Currents, and Shoaling," Miscellaneous Paper H-78-6, US Army Engineer Waterways Experiment Station, Vicksburg, MS.

Trawle, M. J., and Boyd, J. A. 1978 (May). "Effects of Depth on Dredging Frequency, Report 1, Survey of District Offices," Technical Report H-78-5, US Army Engineer Waterways Experiment Station, Vicksburg, MS.

US Army Engineer District, New Orleans, 1973. "Final Environmental Statement, Mississippi River, Baton Rouge to the Gulf of Mexico, Louisiana," New Orleans, LA.

US Army Engineer District, Philadelphia. 1969. "Long-Range Spoil Disposal Study; Part IV, Substudy 3: Development of New Dredging Equipment and Techniques," Philadelphia, PA.

US Army Engineer District, San Francisco. 1979. "Engineering Feasibility Study of a Submerged Salinity Barrier for the John F. Baldwin Ship Channel," San Francisco, CA.

US Army Engineer Waterways Experiment Station. 1984. Shore Protection Manual, 4th ed., Vicksburg, MS.

EM 1110-2-1607  
15 Mar 91

US Department of Commerce, National Oceanic and Atmospheric Administration. "Tide Tables, High and Low Water Predictions" (issued yearly for various coastlines), National Ocean Survey, US Department of Commerce, Rockville, MD.

US Fish and Wildlife Service. 1980. "US Fish and Wildlife Service Mitigation Policy," Federal Register, Vol 46, No. 15 (23 Jan 1982), pp 7644-7663.

van Olphen, H. 1963. An Introduction to Clay Colloid Chemistry, Wiley-Interscience, New York.

Vanoni, V. A., ed. 1975. "Sedimentation Engineering," ASCE Manuals and Reports on Engineering Practice No. 54, American Society of Civil Engineers, New York.

Wells, J. T. 1983. "Fluid-Mud Dynamics in Low-, Moderate-, and High-Tide-Range Environments," Canadian Journal, Fish. Aquatic Sci., Vol 40, Supplement 1, pp 130-142.

Wicker, C. F., ed. 1965 (May). "Evaluation of Present State of Knowledge of Factors Affecting Tidal Hydraulics and Related Phenomena," Report 3, Committee on Tidal Hydraulics, Corps of Engineers, US Army; prepared by US Army Engineer Waterways Experiment Station, Vicksburg, MS.

Wright, L. D. 1971. "Hydrography of South Pass, Mississippi River," Proceedings, American Society of Civil Engineers, Vol 97, No. WW3, p 491-504.

Wright, T. D. 1978 (Aug). "Aquatic Dredged Material Disposal Impacts," Technical Report DS-78-1, US Army Engineer Waterways Experiment Station, Vicksburg, MS.

Wylie, F. E. 1979. Tides and the Pull of the Moon, Stephen Greene Press, Brattleboro, VT.

Yang, C. T. 1972 (Oct). "Unit Stream Power and Sediment Transport," Journal of the Hydraulics Division, ASCE, Vol 98, No. HY10, pp 1805-1826.



APPENDIX B

FIELD DATA CONSIDERATIONS

B-1. General. The collection of field data in an estuary is complicated by three factors: the dynamic nature and the size of estuaries and the importance of episodic events. Because of these factors, the importance of properly designing and executing a data collection program cannot be overstressed. Before actually designing a data collection program, the investigator should conduct the following tasks:

- a. Clearly define the overall scope of the project and list each basic task.
- b. Acquire as much information on the entire system as possible through the review of available data and literature.
- c. Clearly define the objectives or goals of the field data collection program.

Only after these above tasks have been addressed should the actual design of a field data collection program be undertaken. The size of an estuary usually requires that a large number of data collection locations be established, and its dynamic nature requires that the data be synoptic; i.e., collected simultaneously. Together, these two requirements suggest that a meaningful data collection program in an estuary is no small task.

B-2. Types of Prototype Measurements Needed. Typical prototype measurements in estuaries, along with the expected accuracy, purpose, and problems associated with each are summarized in Table B-1. As can be seen, there are nine main categories of data collection to address water resources activities.

TABLE B-1

Prototype Measurements in Estuaries

<u>Type/ Expected Accuracy</u>	<u>Purpose</u>	<u>Problems</u>
1. Water level ±0.05 feet	Tide ranges, datum references, tide propagation, constituents, extreme levels	Usually relative levels are adequately measured, but absolute levels often inadequate, expense of establishing gage zeroes.

(Continued)

TABLE B-1 (Continued)

Type/ Expected Accuracy	Purpose	Problems
2. Currents ±0.15 feet per second	Three-dimensional profile of current, speed, and direction (at least 2-dimensional in horizontal plane), net transport, maximum values, circulation	Low speeds, inadequate spatial coverage, near-bed measurements, wave interference, and survivability of instruments.
3. Bed stresses ±0.1 Newton/ square metre	Shear, pressure fluctuations	Shear must be inferred from velocities/slopes. Placement of pressure sensors is sometimes tricky.
4. Suspended sediments ±5 parts per million	Concentrations, settling velocities, transport rates	Difficult to obtain representative samples plus comments on currents apply.
5. Dissolved materials ±0.1 parts per thousand	Salinity, total dissolved solids	Comments on currents apply.
6. Bed elevation ±1.0 feet	Water depth, erosion/ deposition	Accuracy is very poor, collection is complicated (density dredging, etc.).
7. Bed sediments	Rheology, density, erosional/ depositional behavior, grain sizes, etc.	Sediment characteristics mainly inferred from minerology, etc., or obtained from lab experiments. Undisturbed measurement techniques are needed.
8. Freshwater Inflows 5 percent of flow	Analysis of salinity and freshwater supply.	Defining the boundary conditions and hydrodynamics

(Continued)

TABLE B-1 (Concluded)

Type/ Expected Accuracy	Purpose	Problems
9. Meteorologic Information National Weather Service standards	Effects of atmospheric pres- sure, wind, and surface waves.	Availability of reliable in- formation which is site specific.

B-3. Field Measurements. There are six basic parameters that are typically field measured as part of a field investigation: tide heights and currents, suspended solids, salinity, and bed stresses and elevation. These measurements can be made on a short-term and a long-term basis, the short term usually referring to a period of 13 or 25 hours (one tidal cycle) and the long term from months to many years. Short-term surveys of 13 hours (semidiurnal tide) and 25 hours are sometimes referred to as intensive surveys. Typically, at least two short-term surveys are planned to support a model study (for two different river discharges or two different tidal conditions). Long-term surveys are usually required to conduct rigorous time series analysis of data. Because of the expense of long-term data collection, time series analysis is often limited to tide heights, although such analysis for other parameters is certainly advantageous.

B-4. Other. Factors that will influence the quality of the collected data include

- a. The expertise of personnel designing the program and collecting the data.
- b. Manpower and fiscal constraints, i.e., the number of collection sites versus the number of personnel involved in the collection process (fatigue must be considered when a small number of personnel collect data from numerous sites over a large area for an extended period of time).
- c. Collection platform: above-water (fixed) structure, boat, or moored (in situ) instrumentation.
- d. Meteorologic conditions during the survey.
- e. Freshwater inflow variability.
- f. Type and condition of sample equipment and instrumentation.
- g. Type and condition of laboratory sample processing equipment.
- h. Timeliness of sample processing.

i. Loss of or damage to moored equipment due to accident, foul weather, or vandalism.

j. Local cooperation.

B-5. Precaution Planning. Another area of consideration is that of precaution planning. In general, it is beneficial to have spare parts, extra instrumentation, and alternate plans should one or more of the factors adversely impact the data collection program. The loss of a meter or the mechanical failure of an outboard motor could mean the loss of critical data or perhaps no data at several stations. Attempting to gather this information at a later date would be costly and the additional data may not be consistent with the previous data. Equipment should be inspected regularly during a survey and maintained as needed.

B-6. Personnel Training and Experience. Substantial specialized experience and tidal hydraulics knowledge are required to collect estuarine field data successfully. Experience in inland water data collection is useful, but often insufficient to properly cope with the unique problems of highly unsteady, nonuniform flow and numerous important forcing functions in the estuarine environment. If the data are to be used to verify a model, it is also necessary for an experienced modeler to participate in planning and executing the field data collection so that the specific needs of the model are met. These factors plus the expense of estuarine data collection mandate that appropriately trained and experienced personnel plan and conduct these field programs.

B-7. Example Data Collection Program. The following example describes a short-term (13-hours) data collection effort conducted in the vicinity of Savannah Harbor, Savannah, Georgia (Johnson, Trawle, and Kee 1989). The prototype data were gathered in April 1985 by the US Army Engineer Waterways Experiment Station and the US Army Engineer District, Savannah, and were required to support a numerical model study of Savannah Harbor and vicinity. The objective of the numerical model investigation was to predict the impact of proposed channel deepening on maintenance dredging requirements and salinity intrusion.

B-8. The Savannah Estuary. The Savannah River estuary extends from the Atlantic Ocean to the northwest dividing the states of Georgia and south Carolina. It consists of a series of channels and loops, all interconnected, with the main navigation channel being North Channel and along Front River (Figure B-1). Located on Little Back River is the Savannah National Wildlife Refuge. A tide gate and a sediment trap are located on Back River (Figure B-1). During flood tide, the sediment-laden water flows upstream through the sediment trap with the tide gate open. During ebb, the gate is closed and the water in the Back River area is flushed down Front River. This results in higher ebb velocities in Front River and a decrease in shoaling along the Front River Channel. Tidal influence extends from the mouth upstream approximately 45 miles to Ebenezer Landing.

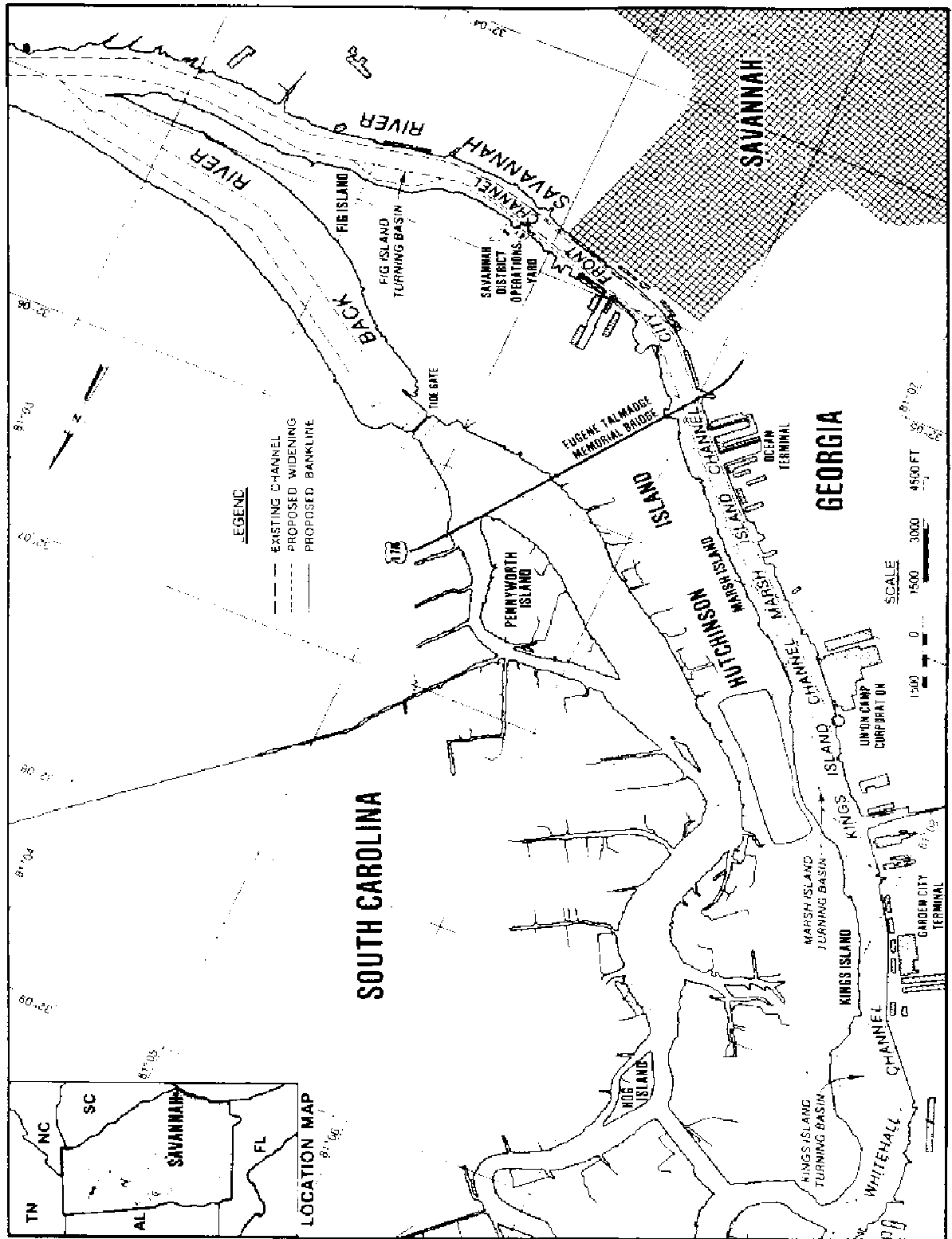

Figure B-1. Location map

15 Mar 91

B-9. Short-Term Survey Plan. During April 1985, an intensive 13-hour survey was conducted along the Savannah River from Fort Pulaski (river mile 0.0) upstream to Ebenezer Landing. The survey consisted of 12 ranges (Figure B-2), each with two or three stations located across the channel. Range 1 was located at Fort Pulaski. Ranges 2 and 3 and Ranges 5 through 7 were established along Front River. Range 4 was located in the sediment trap. Ranges 8, 8A, and 9 were located at Fields Cut, Elba Island Cut, and the Intracoastal Waterway Alternate Route, respectively. Ranges 10 and 11 were established along Little Back River and Range 12 was established at Ebenezer Landing. The locations were chosen to provide a range of data for sediment movement and changes in salinity. This range of data will allow a realistic model simulation of area conditions and changes as opposed to localized changes at the tide gate itself.

B-10. Actual Survey. The 13-hour survey was conducted on 4-5 April 1985 from 0600 to 1900 hour. During the survey, current velocity measurements were taken at 1-hour intervals along the left and right channel prism and along the center line of Ranges 1-6. Range 7 consisted of two transects, one along Front River near river mile 19.7 and another at the junction of Back and Front Rivers where measurements were taken at a single midchannel station. Velocity data are taken at several different depths at each station to determine sediment carrying capacity, distance carried, and also time and direction phasing. This is especially important in the near-bed region where various shear and frictional forces exist at the interface. Current velocity measurements were measured at five depths for each station at Range 1: surface, two-thirds above the bottom, middepth, one-third above the bottom, and 2 feet above the bottom. For Ranges 2 through 7 and Range 12, velocity data were collected at four depths: surface, middepth, 4 feet above the bottom, and bottom. At Ranges 8 through 11, velocity data were collected at three depths: surface, middepth, and bottom. Current velocity measurements were obtained with the use of a magnetic compass indicator and a Price-type current meter. A sample tube was attached to the meter and weight assembly, and water samples were collected to be analyzed later for salinity and suspended sediment concentration.

B-11. In addition to these intensive survey measurements, a number of bed samples were collected by grab sampler at various locations within the estuary to characterize the bed. Settling velocities of suspended sediments were also estimated during the intensive survey using a Niskin tube sampler.

B-12. Tide gages were installed at twelve locations within the estuary 1 month prior to the intensive survey and were in operation during the intensive survey as well as for 30 days preceding the survey.

B-13. Long-Term Survey. This example field survey obtained only 30 days of tide records for long-term data. Depending on the requirements of the study, availability of other data, and resource constraints, it may be necessary to collect other long-term data as part of the survey. For example, proper definition of tidal characteristics may require a minimum of 6 months record. (Twenty-nine years is commonly used for a rigorous determination of tidal

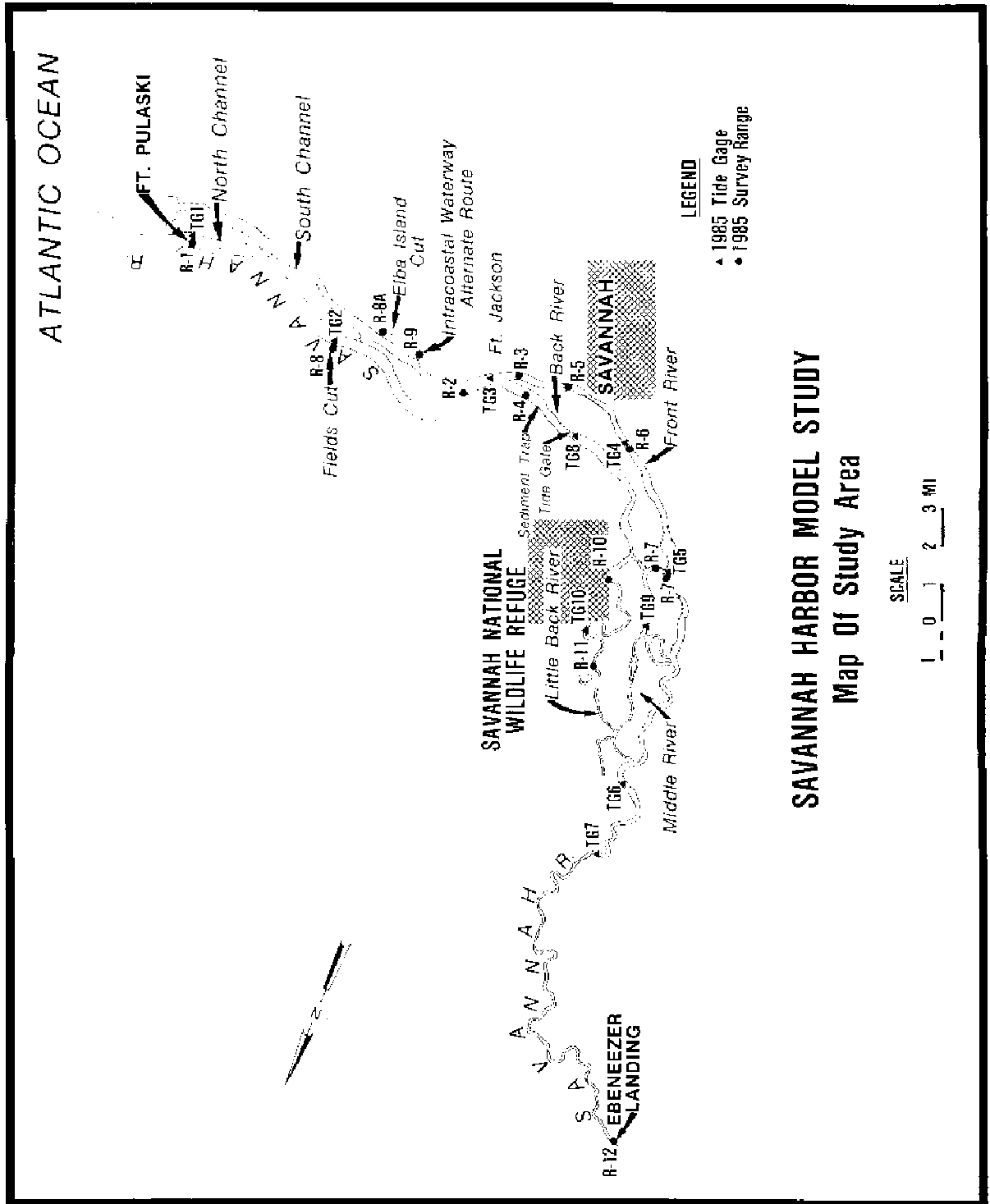

Figure B-2. Study location

EM 1110-2-1607  
15 Mar 91

constituents.) Long-term (30 days to 1 year) velocity, temperature, conductivity, turbidity, wave, and/or meteorological measurements are often obtained to fully define seasonal and episodic event responses of the estuary. These data are collected by recording meters installed for weeks to months and left untended for extended (days to weeks) periods.

B-14. Other Collection Programs. The preceding discussion of the Savannah Harbor data collection program was just one example to indicate the level of complexity. The WES HL has conducted numerous data collection programs with cooperation of several Districts for other problem areas such as location of dredge disposal sites, fate of dredged materials, salinity intrusion, hydraulic transport of contaminated sediment, and other parameters of estuarine hydrodynamics. The locations of the field collection programs have included the east, Gulf, and west coasts, and their descriptions are given in various WES technical reports. Please refer to Appendix F or contact HL for specific information.



APPENDIX C

NUMERICAL MODEL INVESTIGATION OF THE SAVANNAH RIVER ESTUARY

C-1. Introduction.

a. A description of the Savannah River estuary (Figure C-1) is given in Appendix B, paragraph B-8, of this EM and will not be repeated here.

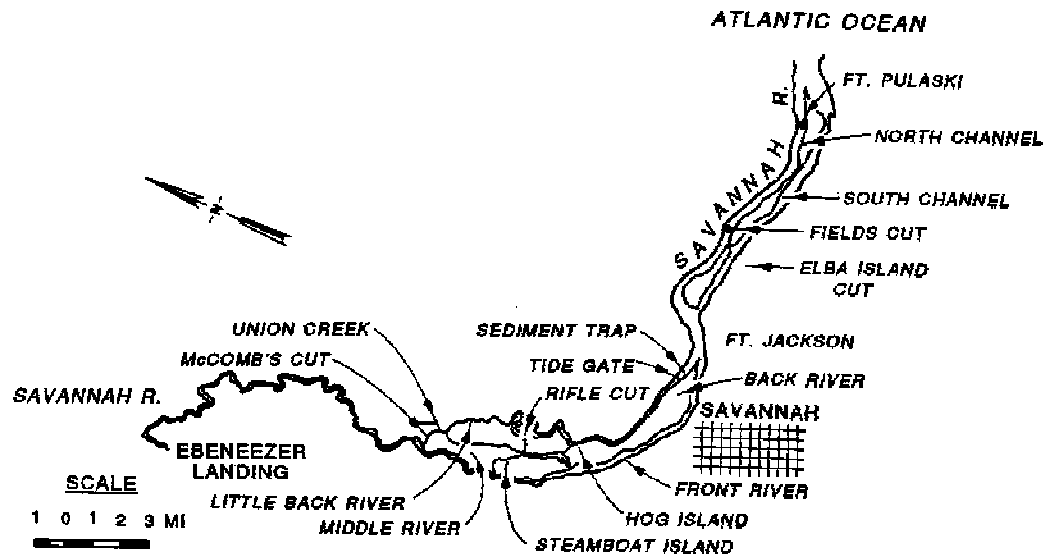

Figure C-1. Savannah River estuary

b. The objectives of the numerical modeling effort were threefold: to predict the impact of channel deepening and widening on salinity intrusion, on channel shoaling (maintenance dredging requirements), and on navigation safety along Front River.

c. To address the first two objectives, a laterally averaged finite difference model named LAEMSED was applied. To address the third objective a ship simulator study was conducted (Hewlett, Daggett, and Heltzel 1987). To provide the channel currents required to conduct the ship simulator study, a depth-averaged, finite element model called RMA-2V was used.

C-2. Salinity Intrusion and Shoaling Study--LAEMSED.

a. Numerical Grid. The modeled area extends along Front River from river mile 0.0 (10 miles downstream from Fort Pulaski) approximately 45 miles upstream to Ebenezer Landing (river mile 44.7). Grid generation consisted of segmenting the Savannah River system into 16 distinct branches as listed in Table C-1 and shown in Figure C-2. The vertical grid spacing on each branch was 3.0 feet. A computational time step of 60 seconds was employed. The schematization of each branch is listed in Table C-2.

TABLE C-1  
Branches of Savannah River

<u>Branch</u>	<u>Location</u>
1	Ebenezer Landing through McComb's Cut along Little Back River to Front River
2	From McComb's Cut down Front River to 10 miles seaward of Fort Pulaski
3	Connection from Front River to Hog Island on Back River
4	Middle River
5	Steamboat Island Channel
6	South Channel from Front River to Ocean
7	Elba Island Cut
8	Marsh channel on Back River
9	Marsh channel on Back River
10	Marsh channel on Front River
11	Marsh channel on Little Back River
12	Marsh channel on Little Back River
13	Marsh channel on Front River
14	Rifle Cut
15	Marsh channel on Middle River
16	Union Creek

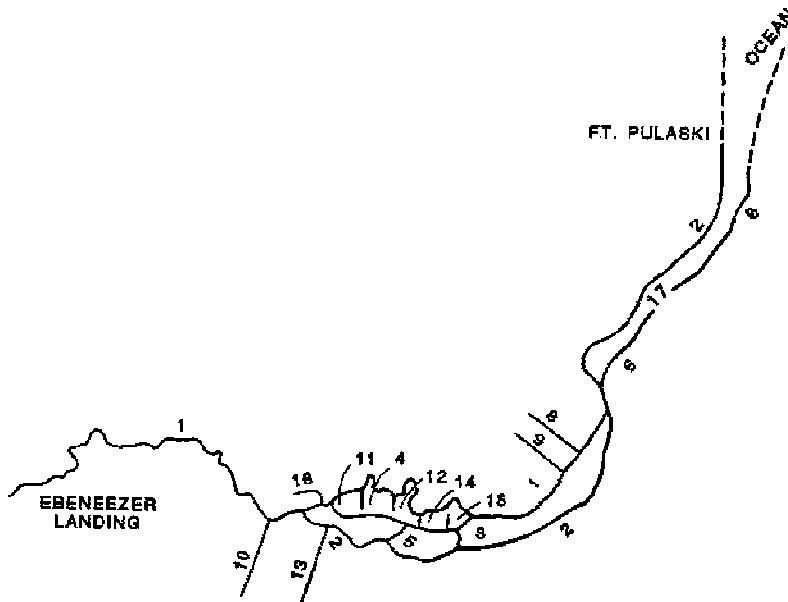

Figure C-2. LAEMSED branch locations

TABLE C-2  
Schematization

<u>Branch</u>	<u><math>\Delta x</math>, m</u>	<u>No. of <math>\Delta x</math>'s</u>
1	1,074	55
2	1,610	36
3	1,000	4
4	1,006	8
5	386	6
6	1,610	19
7	468	3
8	4,000	4
9	4,000	4
10	2,500	4
11	4,000	4
12	4,000	4
13	4,000	4
14	200	4
15	4,000	4
16	1,000	4

Note:  $\Delta x$  = distance between nodes  
(computational points)

b. Boundary Conditions. Daily averaged freshwater inflows at Ebenezer Landing and tides at Fort Pulaski were recorded for several days before and after the initiation of the 13-hour detailed field survey. Ten tidal cycles were used as a "start-up" period. Tidal data at Fort Pulaski were translated to the ocean boundaries of branches A and F which extended 10 miles into the ocean. A constant salinity of 33 parts per thousand was prescribed at these boundaries. In this application the sediment computations were turned off and thus no sediment boundary conditions were required.

c. Model Verification. To match observed tides, velocities, and salinities at interior locations, the Chezy roughness coefficient and off-channel storage were adjusted. Initial estimates of storage in particular reaches were determined from National Oceanic and Atmospheric Administration/National Ocean Survey (NOAA/NOS) nautical charts showing the limits of flooding. Values of the Chezy coefficient ranged from 60 metres per second in the navigation channel to 30 metres per second in Back and Middle Rivers.

d. Tide Gate Operation. The tide gate is a gravity-operated structure. Therefore, when the water level on the riverside exceeds that on the ocean side, LAEMSED initiates the closing of the gate. This is accomplished by decreasing the Chezy coefficient in the reach containing the gate by a factor of 10 over the next 10 time-steps (a period of 10 minutes). At the end of the tenth time-step, flow through the gate is completely stopped. This procedure reduces the initial shock to the computations caused by the closing of the

gate. When the water level on the ocean side is greater than the riverside level, water is allowed to pass through the reach containing the gate in a normal fashion.

e. Results. Figures C-3 through C-5 show typical comparisons of computed and recorded tides, velocities, and salinities at Fort Jackson. As can be seen, excellent agreement of tidal ranges and phases as well as vertical distributions of velocities and salinities has been achieved.

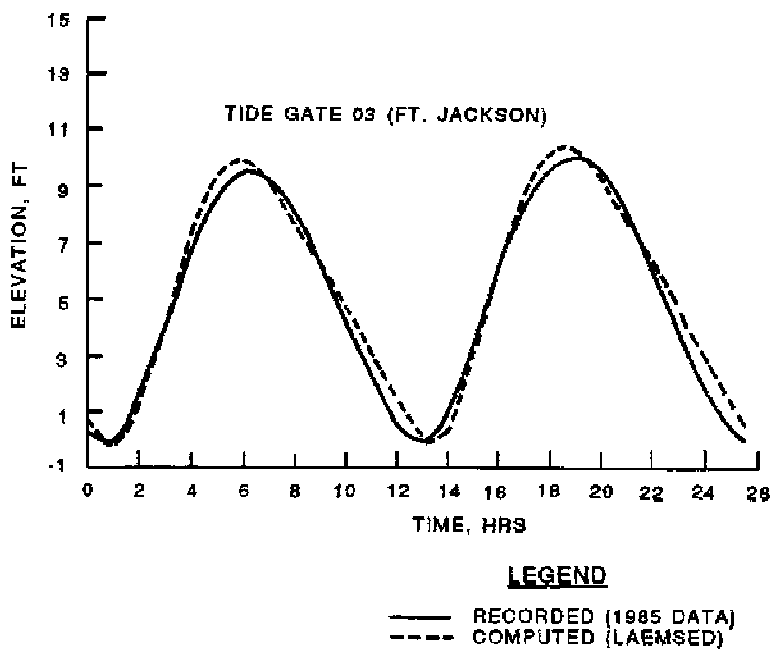

Figure C-3. Computed versus recorded 1985 tides at Fort Jackson

f. Sediment Verification. Adjustment of the model's critical shear stresses and erosion rate constants to reproduce shoaling rates was accomplished by running the model for the complete 28-day cycle of tides recorded at Fort Pulaski during the 1985 survey. Computed shoaling rates along Front River and in the sediment trap were then compared with estimates based upon dredging records from 1977 to 1980.

g. Boundary Conditions. The tidal record at Fort Pulaski was prescribed at the ocean boundaries with either a low (5,200 cubic feet per second), normal (8,400 cubic feet per second) or high (16,000 cubic feet per second) constant freshwater inflow prescribed at Ebenezer Landing. Based on 1985 survey measurements, constant suspended sediment concentrations of 30 and 300 parts per million were specified as boundary conditions at Ebenezer Landing and the ocean boundaries, respectively. The boundary condition on salinity was as previously discussed. The 30-part-per-million concentration was applied uniformly from surface to bottom at Ebenezer Landing, and the

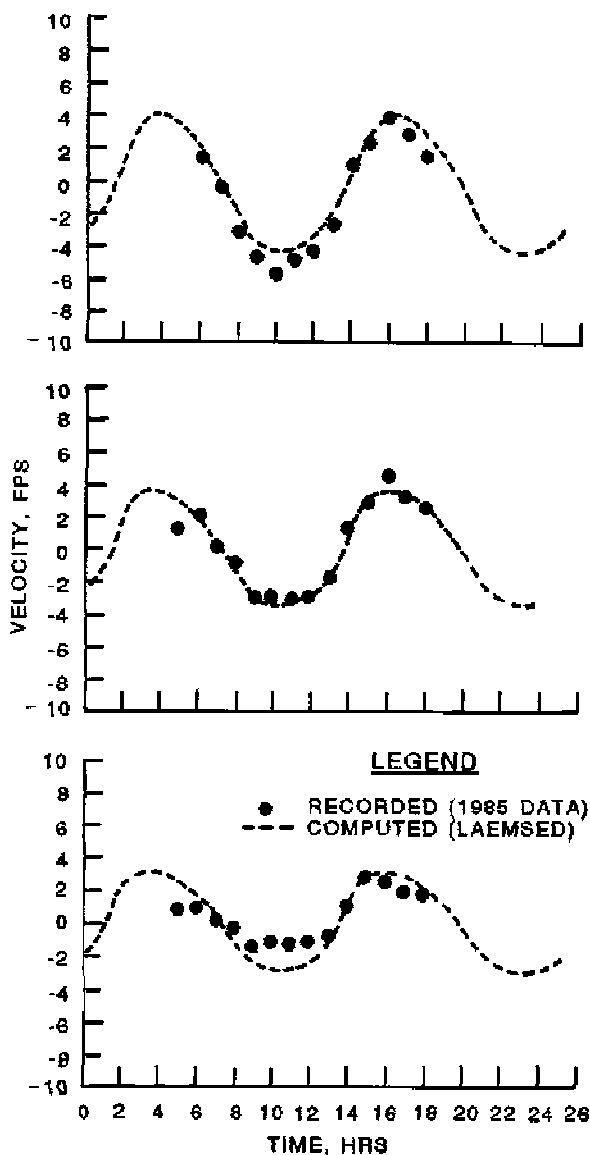

Figure C-4. Computed versus recorded 1985 velocities at Fort Jackson

300 parts per million uniformly from surface to bottom at the ocean boundary.

h. Bed Model. Shoaling problems in the Savannah Estuary result primarily from the deposition of fine-grained material. Thus the sediment was considered to be a clay. Initially, the channel bed was set to project depth in the navigation channels and to NOS chart depths elsewhere, with a spatially uniform concentration of suspended sediment of 30 parts per million in the water column. Only two layers were allowed in the bed model. The critical shear stress for erosion was set to be 0.6 Newton per square metre in the top

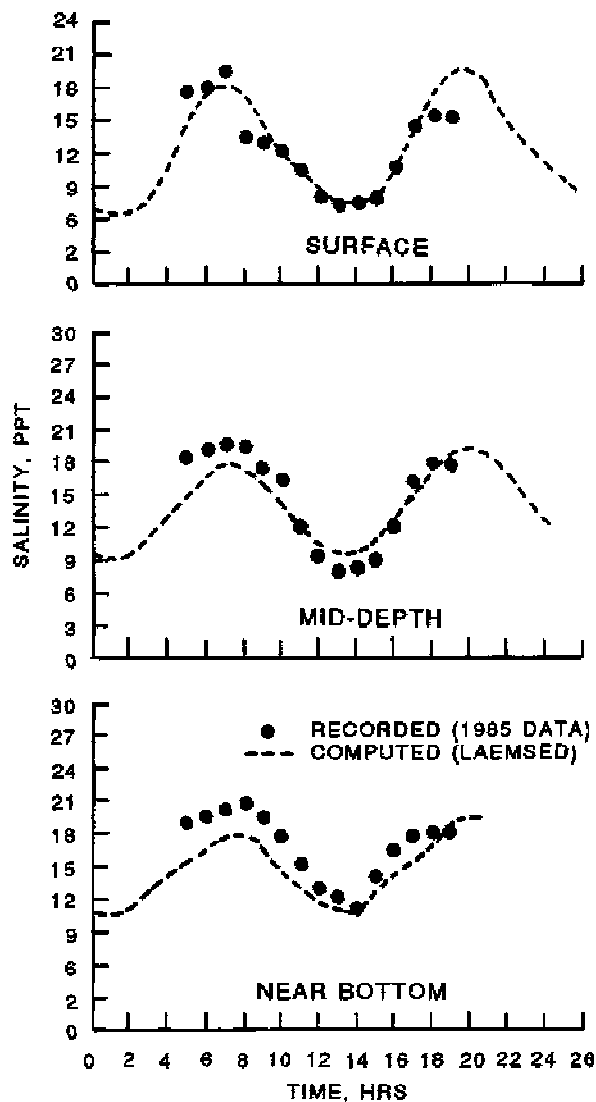

Figure C-5. Computed versus recorded 1985 salinities at Fort Jackson

layer and 1.0 Newton per square metre in the second layer. The thickness of the upper layer was set to be constant at 0.01 metre, whereas the bottom layer thickness was variable. The concentration of material in both layers was taken as 400 kilograms per cubic metre, yielding a bulk density of the bed of 1.25 grams per cubic centimetre.

i. Results. Figure C-6 compares computed infill rates determined from 1977-1980 dredging records. The computed values were determined first as an average over the 28-day cycle of tides and then extrapolated to provide yearly averages. Little difference in shoaling rates was computed for the different

freshwater inflows. Those shown in Figure C-6 are for a normal freshwater inflow.

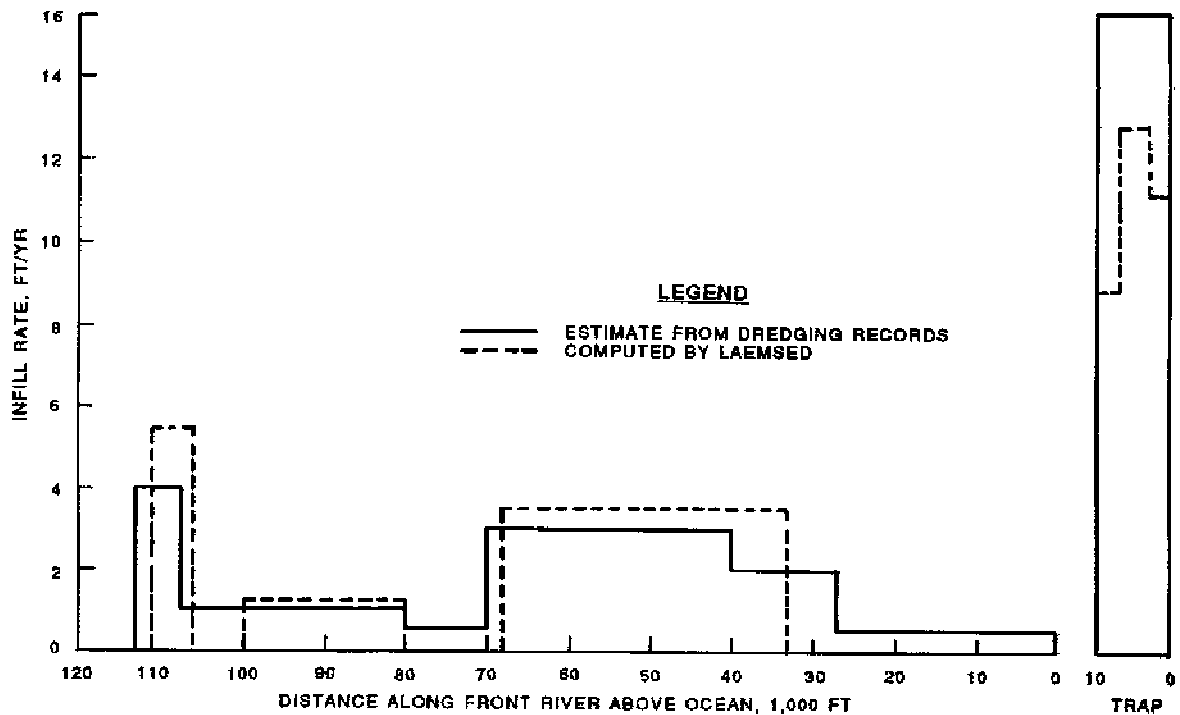

Figure C-6. Shoaling distribution in navigation channel

C-3. Tidal Currents for Navigation Study--RMA-2V.

a. Of all the data required to develop a detailed scenario for a navigation channel design study, obtaining the currents in the waterway for both the existing and proposed channels is extremely important yet difficult to obtain. Currents are typically the primary source of difficulty in maneuvering a ship in a restricted waterway. To obtain these values, a finite element model of the area of a portion of the Savannah River as shown in Figure C-7 was developed. This procedure is discussed in Thomas and McAnally (1985). The finite element mesh (Figure C-8) was refined to provide adequate detail across and along the river. The model bottom definition was derived from the latest available hydrographic survey (Hewlett, Daggett, and Heltzel 1987), which was modified to reflect dredging for the proposed planned channel.

b. For the model verification boundary conditions, the US Army Engineer Waterways Experiment Station conducted a field study in the Savannah estuary in April 1985 (see Appendix B for details). Tides, velocities, salinities, and suspended sediment concentrations were recorded at several locations along the estuary from the mouth to the upstream end of tidal intrusion. The tidal and velocity measurements in the vicinity of the numerical model mesh provided

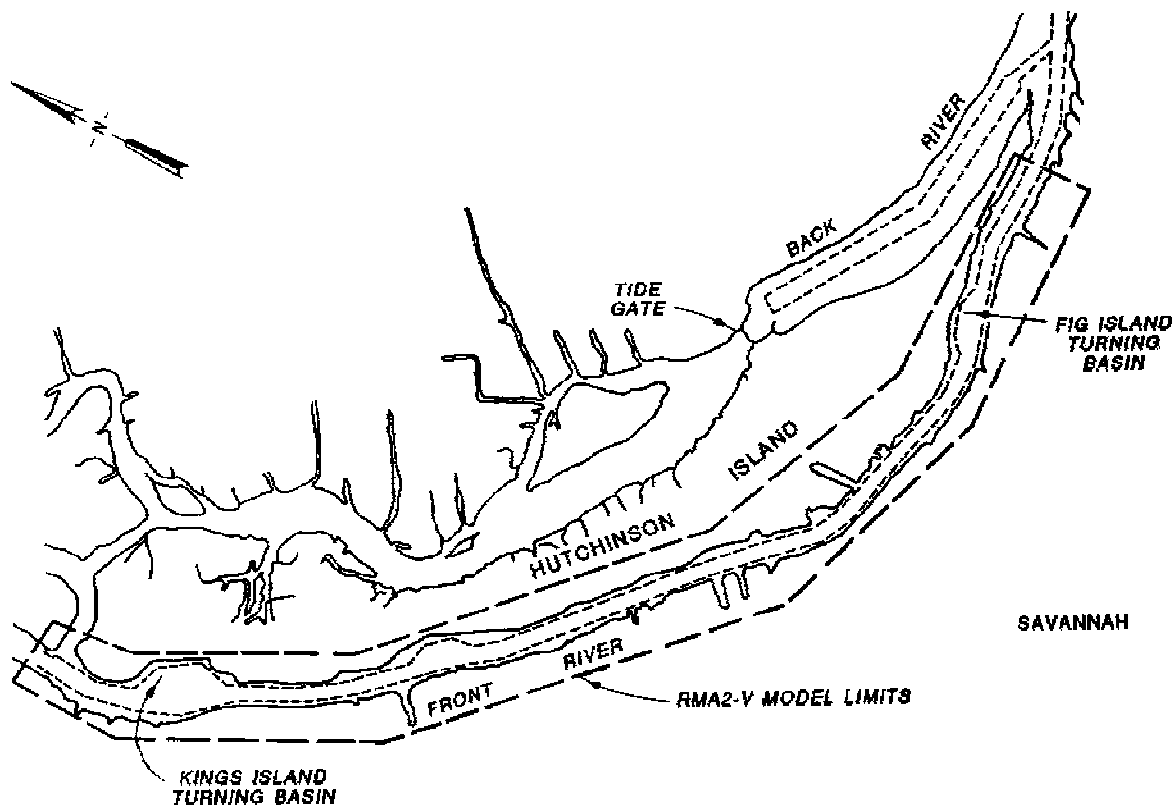

Figure C-7. Savannah Harbor

the data necessary to develop boundary conditions and to ensure that the model was reproducing tidal velocity conditions within the mesh in a reasonable manner necessary to run the numerical model for a complete tidal cycle.

c. Prototype data and model results were compared at two different cross sections in the existing channel model. One of these cross sections was immediately downstream of the US Army Engineer District, Savannah, operations yard, and the other was upstream of the Talmadge Bridge at the location of the Diamond Construction Company's dock on the north bank, stations R-5 and R-6 in Figure C-9. Figure C-10 shows an example of the comparison of the field data and the numerical model results. As can be seen, agreement is close. An example plot of the current vectors from the finite element model is shown in Figure C-11.

C-4. Typical Results from Deepening Study.

a. Typical study results regarding the impact of channel enlargement on salinity intrusion predicted from the LAEMSED model are shown in Figure C-12. Typical sedimentation results, again predicted from the LAEMSED model, are given in Figure C-13.



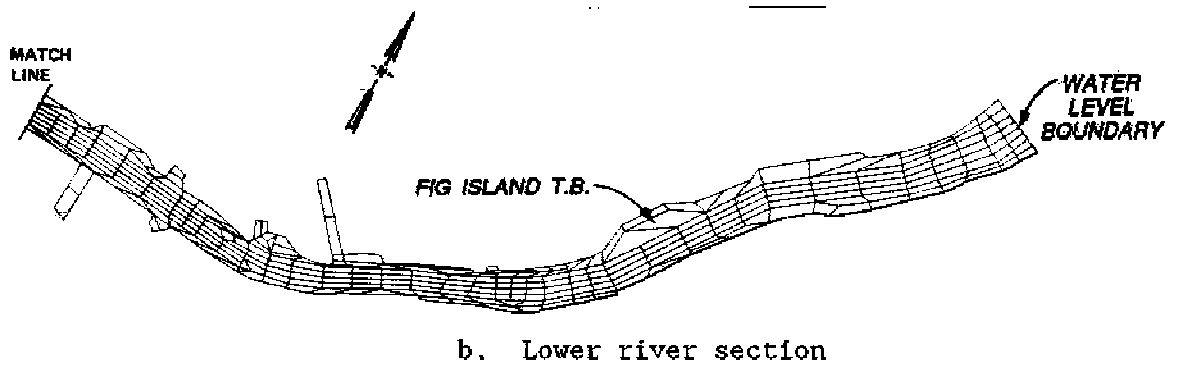
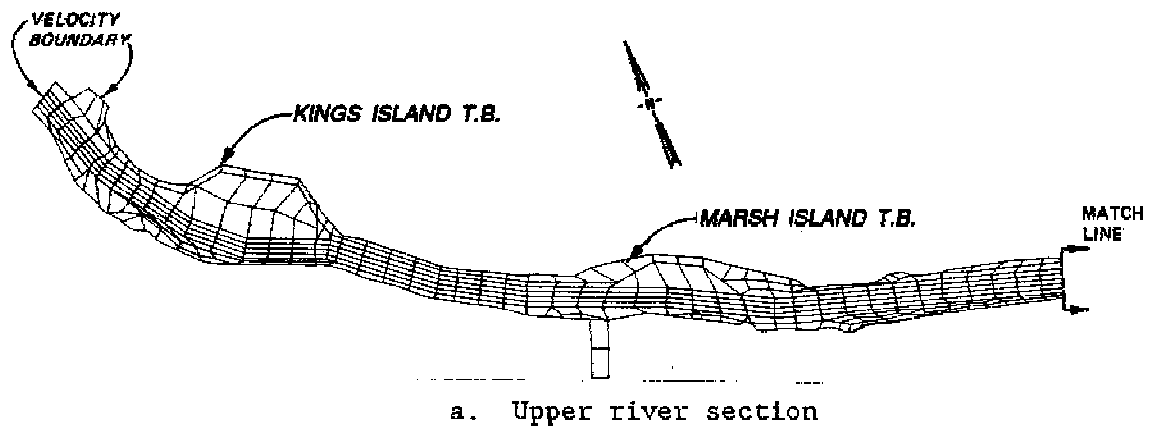

Figure C-8. Existing channel and tidal basin RMA-2V grid

b. Typical results from the ship simulator study, which used the currents from the RMA-2V hydrodynamic model, are shown in Figure C-14.

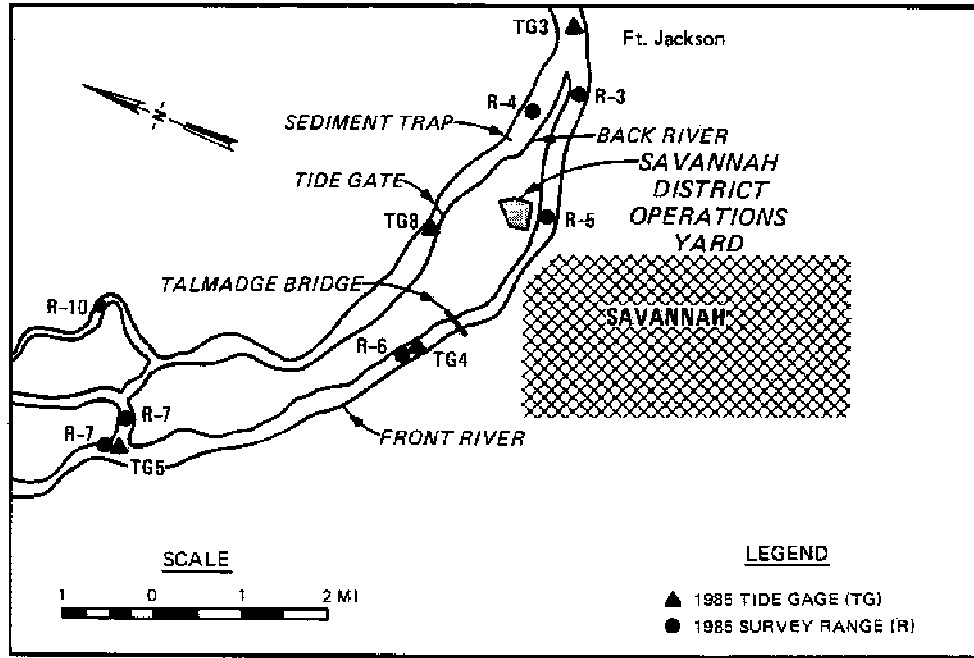

Figure C-9. Prototype measurement locations for Savannah Harbor ship simulation study

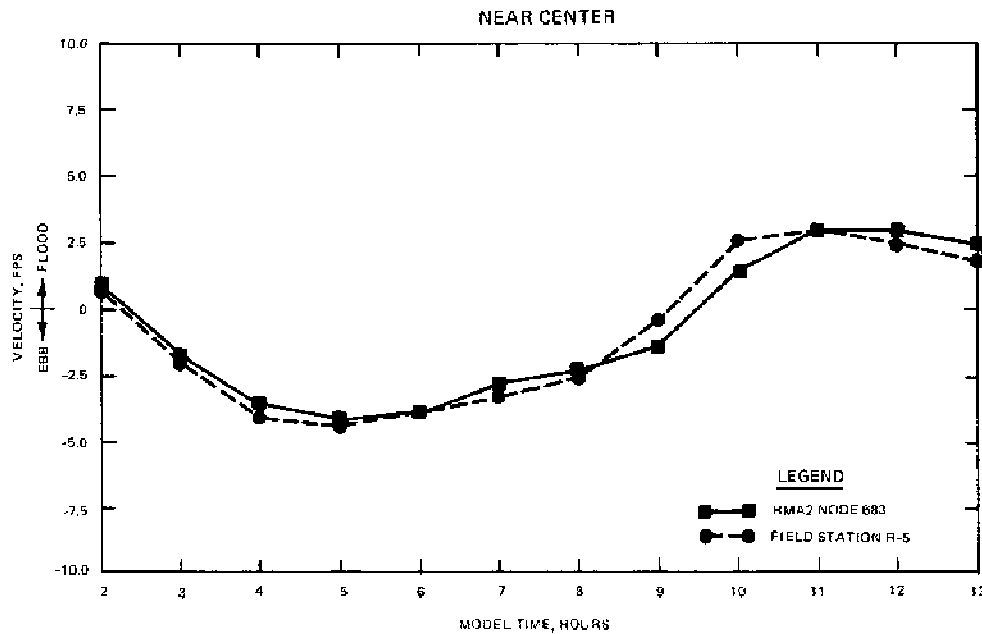

Figure C-10. Model-field velocity comparison at station R-5

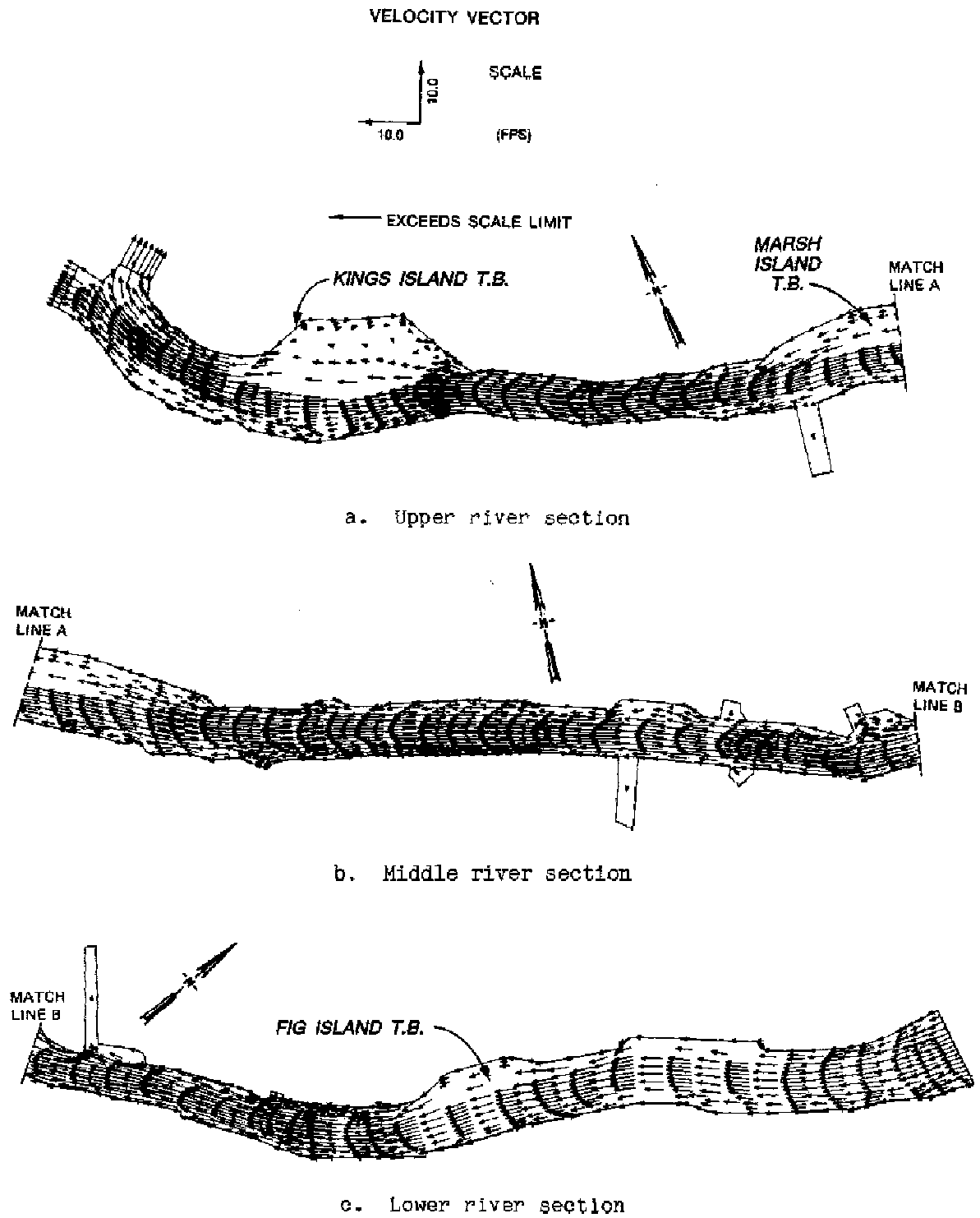

Figure C-11. Maximum flood velocities, existing channel,  
10.5-foot tidal range

EM 1110-2-1607  
 15 Mar 91

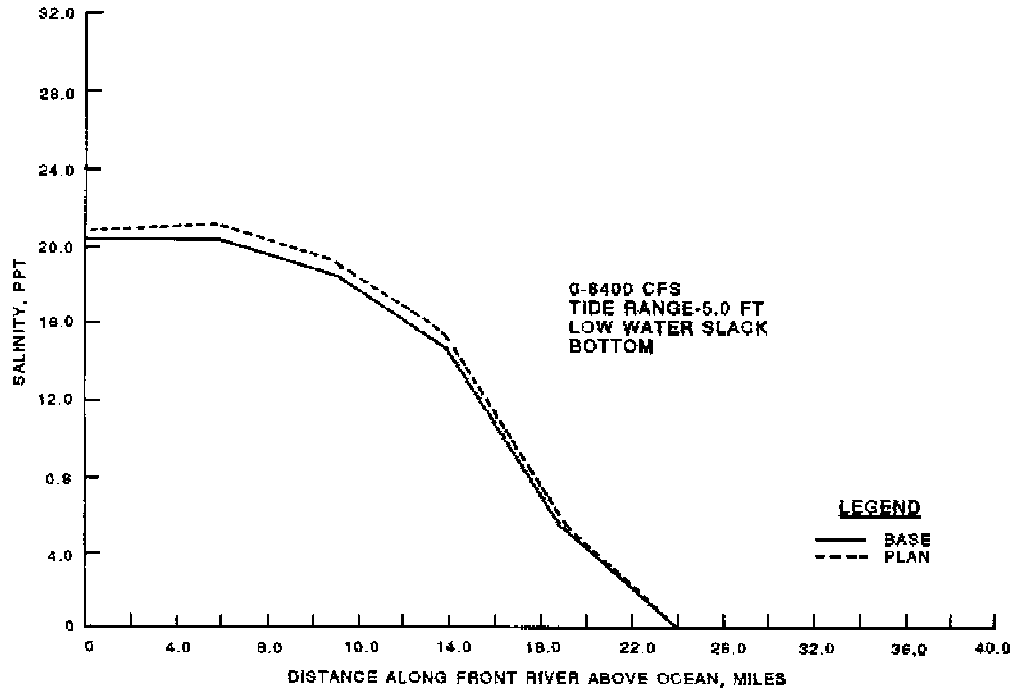

Figure C-12. Salinity change predicted by LAEMSED model

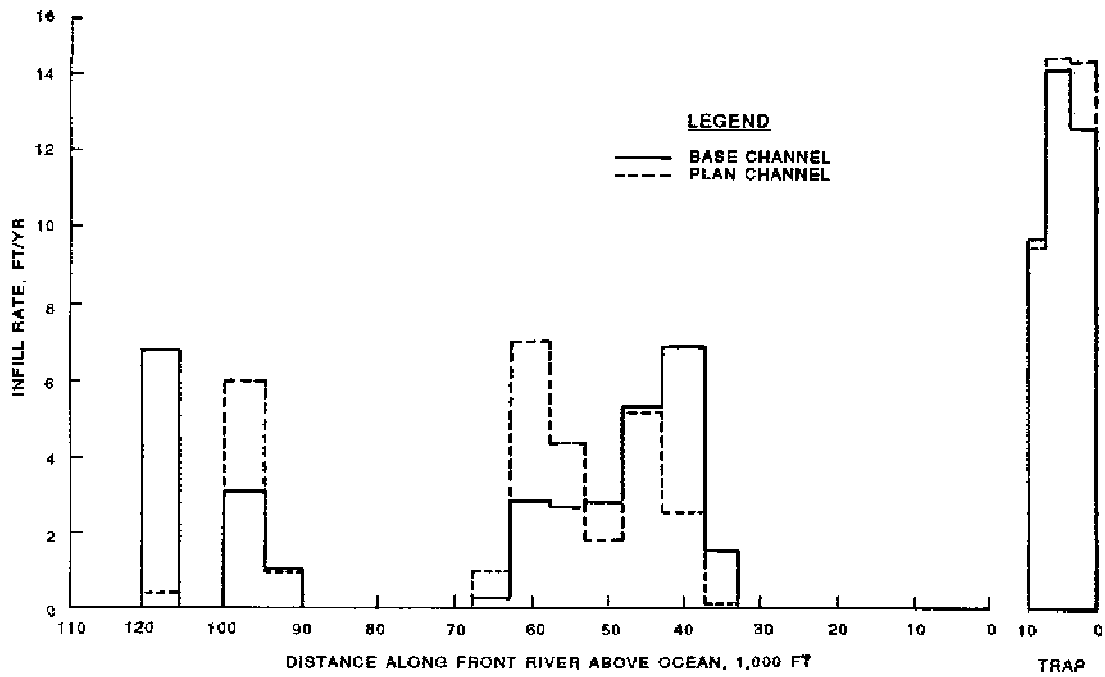

Figure C-13. Comparison of base and plan shoaling

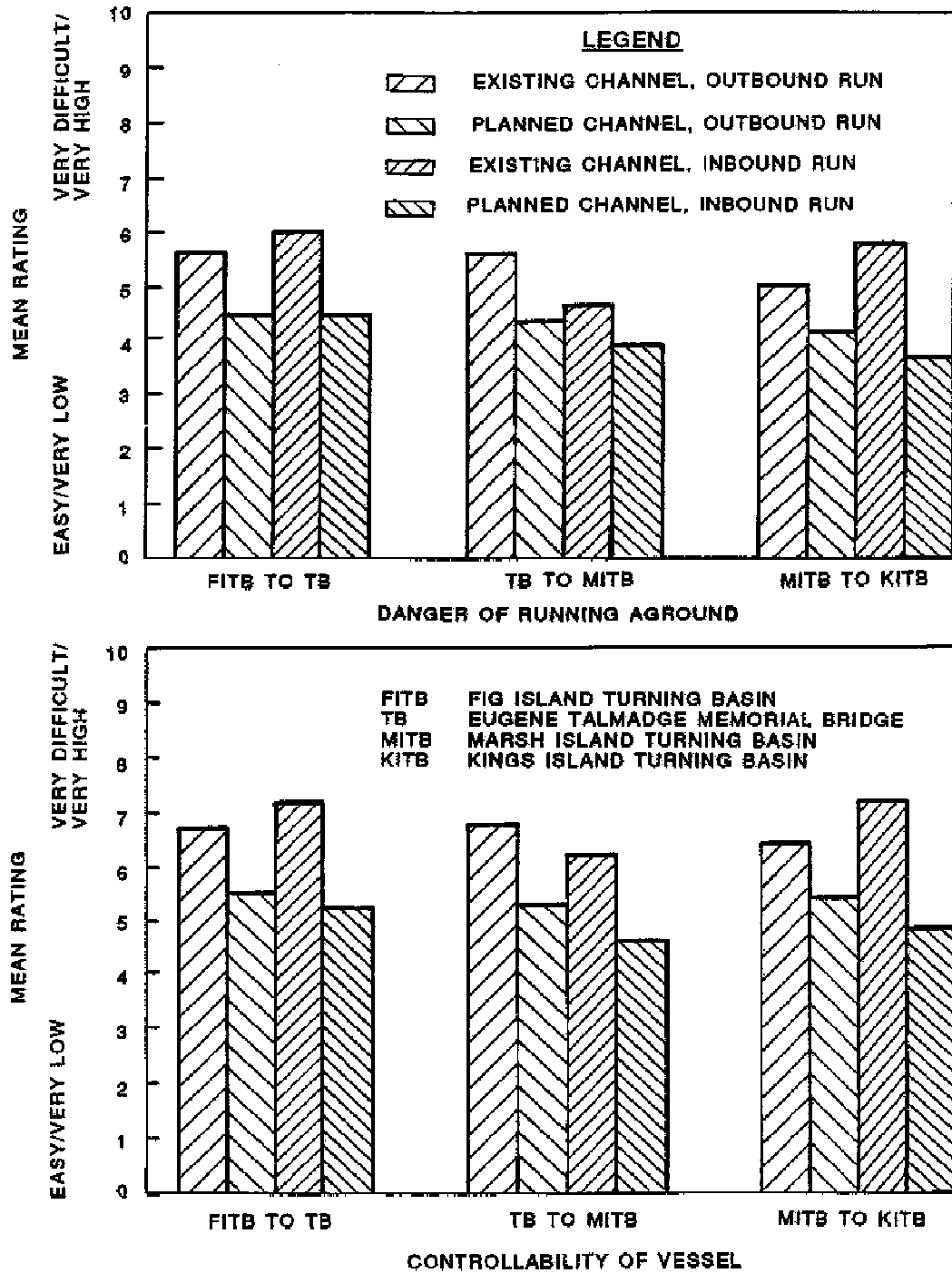

Figure C-14. Typical results from the ship simulator study

APPENDIX D

ESTUARINE SEDIMENTATION ANALYSIS

D-1. Sediment Sources. Identification of the sources of sediment can be a key factor in problem solving. Original sources are upland, internal, and coastal. Section D-11, subparagraphs c-e, describe the evaluation of transport routes that comprise immediate (local) sources.

a. Upland. The predominant source usually is from surface erosion of lands draining into the water body, but sediments eroded from riverbanks also contribute. In some cases, flows from the upland may carry significant quantities of organic material.

b. Internal. Currents and waves resuspend sediments from bed and banks within the estuary, and aeolian transport introduces sediment in a more direct manner. In biologically active areas, organic production within marshes and the main estuarial water body itself can significantly enhance total suspended solids and shoal volumes (Kranck 1979). Wastes can add considerably to organic loading.

c. Coastal. Close to the estuarial mouth, the sediment is often of marine origin. In areas where the open seacoasts are sandy, it is common to find the bed in the mouth or entrance channel to consist predominantly of sand. Landward of the entrance the grain size decreases and the fraction of fine-grained material tends to increase (Mehta and Jones 1977). In some estuaries, such as the Mississippi or the Amazon Rivers, where sediment supply from upstream sources has been relatively high on a geologic time scale, the offshore ebb delta is laden with deep layers of fine-grained material (Gibbs 1977; Wells 1983). Thus density- and tide-driven flows can transport some of the fine-grained ebb deltaic deposits (resuspended during flood flows coupled, oftentimes, with offshore wave activity) upstream through the channel. The material is then redeposited in reaches where the currents are too weak to transport the material further or at the nodal point for bottom flow predominance (Partheniades 1966).

D-2. Sediment Classification. For engineering purposes, sediments are customarily classified primarily according to particle size. Sediment of size greater than about 0.074 mm (No. 200 sieve size) is considered to be coarse sediments, and less than this size to be fine-grained sediments. The terms "coarse" and "fine" are relative to fine-grained sedimentation and not the American Society for Testing and Materials (ASTM) class. The boundary between cohesive and cohesionless sediment is not clearly defined and generally varies with the type of material. Cohesion generally increases with decreasing particle size. Thus clays (particle size <0.005 mm) are much more cohesive than silts (0.005 to 0.074 mm), and, in fact, cohesion in natural muds is due primarily to the presence of clay-sized sediment. Silt-sized material (particularly of size larger than ~0.02 mm) is only weakly cohesive, but when in combination with a sizeable fraction (by weight) of clayey sediment,

constitutes a sediment which, in the flocculated state, exhibits a behavior characteristic of cohesive sediments.

a. Muds. Estuarial muds are typically composed of a wide range of materials including clay and nonclay minerals in the clay- and silt-size ranges, organic matter, and sometimes small quantities of very fine sand. Muds often occur in the presence of coarse sand, shell, and other macrosized detritus.

b. Size. The particle size distribution of coarse materials is easily determined by sieve analysis, and reported either in terms of diameter  $d$  or in  $\phi$  units (i.e., as  $-\log_2 d$ ). It is most common to characterize the size distribution by the median (by weight) size and the corresponding variance, standard deviation, uniformity coefficient, or sorting coefficient (Terzaghi and Peck 1966; Vanoni 1975; and US Army Engineer Waterways Experiment Station 1984). Skewness and kurtosis, particularly the latter, are less commonly used mainly because the degree of acceptable accuracy in typical sediment transport calculations does not warrant the use of these size-distribution characterizing parameters. However, they can be useful indicators of sediment sorting in studies meant to examine spatial sorting trends, e.g., of the bottom sediment with distance along the estuary.

c. Settling Velocity. The customary practice of reporting grain-size distribution has arisen out of the simplicity of sieve analysis as a measuring technique. It must, however, be noted that the key transport-related parameter is the settling velocity, which, unfortunately, does not bear a unique relationship with particle size. Laboratory settling columns can be used to measure settling velocity distribution, which may be considered as a very useful property for sediment classification (Channon 1971; Vanoni 1975).

d. Cohesive Treatment. Cohesive sediments are deflocculated, or dispersed, by removing salts from the fluid through repeated washing with salt-free water and adding a dispersing agent such as sodium-hexametaphosphate prior to particle size determination. Standard hydrometer or pipette methods are used to determine the dispersed particle size distribution (ASTM 1964). The original sample should not be dried before determining the size distribution, inasmuch as prior drying prevents the material from dispersing adequately (Krone 1962).

e. Deflocculation. Cohesive sediment size distribution obtained without dispersion will be that of the flocculated material, which bears no unique relationship to that of the dispersed material. The floc size distribution yields a qualitative indication of sediment behavior in the prototype.

f. Settling Tests. A convenient laboratory procedure for obtaining the settling velocity of flocculated sediment consists of settling tests in a column. Sediment samples are withdrawn at various elevations and different times after test initiation (Owen 1976; Vanoni 1975; Teeter and Pankow 1989a). This procedure yields an empirical relationship between the median settling velocity and suspended sediment concentration, which is unique to the type of

sediment-fluid mixture used (see also section D-6 and D-7). It is preferable to use the actual estuarial fluid in these tests. If conditions permit, field tests are recommended (Owen 1971; Teeter and Pankow 1989a).

D-3. Coarse Sediment Transport. Coarse-grained sediment includes material larger than about 0.074 mm (74  $\mu$ m), the most common sediment being sand, although some estuarial beds are laden wholly with coarser material including shells and gravel (Kirby 1969).

a. With reference to sand transport, the estuarial mouth or tidal entrance can be in many cases conveniently treated as a geomorphologic unit separately from the remainder of the estuary. Sediment transport is influenced strongly by the hydrodynamics of flood and ebb flows within the entrance channel and over the flood and ebb shoals adjacent to the channel (Mehta and Joshi 1984). In the ebb shoal area in the sea, tidal flows interact with crosscurrent generated typically by wave-driven alongshore flows. Penetration of waves from the sea into the entrance channel, particularly during flood, can have a marked effect on the rate of sediment transport and the distribution of bottom sediment (Bruun 1978; O'Brien 1969).

b. The application of sediment transport formula developed for unidirectional flows is usually suitable to tide-dominated oscillatory flows because the tidal frequency is low, and tidal currents may be considered to be "piecewise" steady. Differences tend to arise due mainly to three causes:

(1) The complexity of flow distribution resulting from salinity effects.

(2) The condition of slack water and flow reversal following slack.

(3) The dependence of bed forms and associated bed resistance on the stage of tide and the direction of flow.

c. The total rate of sediment transport is the sum of contributions from bed load and suspended load. Bed load rate varies with  $n^{\text{th}}$  power of the excess shear stress. Values of the exponent  $n$  have been found to vary from less than 1.5 to as high as 3 (Vanoni 1975; Yang 1972). Generally, for the coarse beds the exponent is nearer 1.5; for fine material the exponent is nearer 3.

d. Bed material load is a term which is sometimes confused with bed load. Bed material load means that portion of the total load represented in the bed and includes bed load and suspended bed material. The remainder is wash load, typically fine-grained and, unlike bed material load, it is believed to be independent (uncorrelated) of flow condition. Bed load is that material moving on or near the bed. The stochastic nature of nearbed turbulence and associated sediment transport indicates that a given material can behave either as wash load or as bed material load, depending upon the properties of the material and the flow condition (Partheniades 1966).



e. Whether a sediment under a given flow condition behaves as bed load or as suspended bed material load depends on the relationship between the entrainment function,  $\Theta$ , and the dimensionless grain size,  $d_{gr}$ , as illustrated in Figure D-1 (Ackers 1972). Here

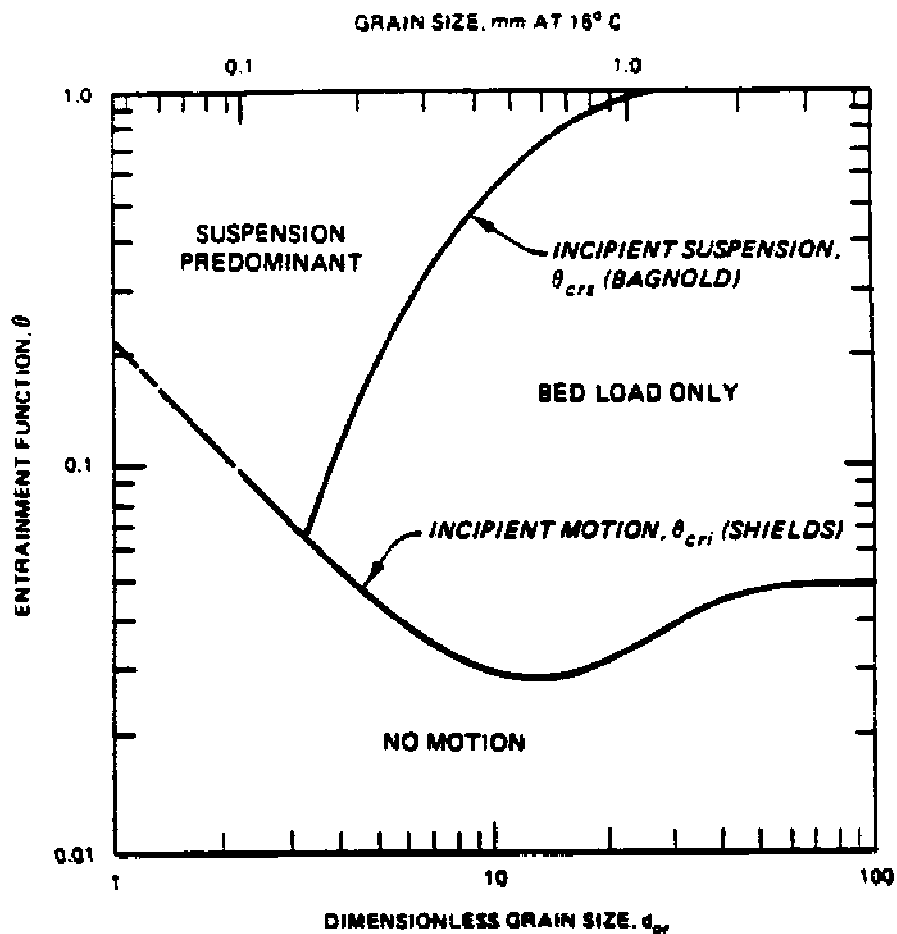

Figure D-1. Relationship between entrainment function,  $\Theta$ , and dimensionless grain size,  $d_{gr}$  (after Ackers 1972)

$$\Theta = \frac{\tau_b}{(\gamma_s - \gamma)d} \tag{D-1}$$

$$d_{gr} = d \left\{ g \left[ \frac{(\gamma_s - \gamma)}{\gamma v^2} \right] \right\}^{1/3} \tag{D-2}$$

where

$\tau_b$  = bed shear stress  
 $\gamma_b$  = unit weight of the sediment  
 $\gamma_s$  = unit weight of water  
 $d$  = grain size  
 $g$  = acceleration due to gravity  
 $\nu$  = kinematic viscosity of the fluid

In Figure D-1, the lower curve corresponds to Shields' relationship which defines a critical value  $\Theta_{cri}$  of the entrainment function whose magnitude depends on the roughness Bagnold's number,  $u_*d/\nu$  (where  $u_*$  is the friction velocity) (Shields 1936). At values below  $\Theta_{cri}$  there is negligible motion of bed material. The upper curve corresponds to Bagnold's (1966) relationship which defines another critical value,  $\Theta_{crs}$ . Above this value of  $\Theta$  the sediment is transported predominantly in suspension. Between the two curves is the domain in which bed-load transport occurs. By virtue of the nature of these two curves, which intersect at a point corresponding to  $d_{gr} \approx 3.2$ , for particle sizes that correspond to  $d_{gr}$  smaller than this value, transport is predominantly in suspension. Indeed for particles of sizes less than about 0.04-0.06 mm, bed-load transport does not occur (Mehta and Partheniades 1975).

f. The contribution of suspended load relative to bed load (in total load) depends on the grain size, the flow regime, and the estuarial morphology. In most estuaries, bed load is a small fraction of the total sediment load.

g. The rate of supply of "new" sediment from the river varies widely from one estuary to another, and, in a given estuary, there is usually a strong seasonal dependence as well (Krone 1979). Normally, however, the oscillatory, "to and fro," tide-controlled transport is orders of magnitude higher than the net (incoming minus outgoing) input of sediment. By the same token, the residence time of incoming sediment is usually very long and, in some cases the material is "permanently" deposited in the estuarial bed. In the long term, such factors as changes in the upstream discharge hydrograph and sediment supply rates, morphologic changes within the estuary, sea level change, and eustatic effects will alter the sediment transport regime (Dyer 1973; McDowell and O'Connor 1977). Generally estuaries import sediment and are filling with sediment.

h. Closure or tidal choking is a potential problem at sandy entrances where the strength of flow is insufficient to scour the bed, with the result that littoral drift is deposited in the mouth, the depths become shallow, and the entrance eventually closes (Bruun 1978). As a result of runoff, however, closure will be restricted to times of very low freshwater outflows, since at other times a hydrostatic head will build up sufficiently to cause an eventual breakthrough at the site of sand deposition in the mouth. When the mouth is closed, the estuary changes into a lagoon or lake of brackish water. There is no access to the sea, and water quality degradation often occurs. Training

walls or jetties and dredging between the jetties coupled, sometimes, with a system for bypassing sand from the updrift beach to the downdrift beach can be used to keep entrances open (Bruun 1978).

i. Sand in transport can form waves. Sand waves occur where flows are strong and sediment supply sufficiently large. Sand waves are described as either dunes (migrate downstream) or as antidunes (migrate upstream). Dunes are by far the most common sand waves observed in rivers and estuaries. In estuaries they can grow to heights of 10 to 20 feet with wavelengths of hundreds of feet, and can impede navigation.

D-4. Cohesive Sediment Transport. Cohesion greatly influences the behavior of sediment materials and their transport processes. Cohesion results from interparticle electrochemical forces, which become increasingly important relative to the gravitational force with decreasing particle size below 0.04 mm. Clays, which have sizes less than 0.005 mm, are particularly cohesive.

a. At moderate suspended solids concentrations, depositing cohesive aggregates stick to the bed, and as they accumulate, buried aggregates are consolidated by the weight of the overburden. The strength of a deposit therefore increases with depth below its surface. The shear strength of a deposit must be overcome by the hydraulic shear stress before erosion begins. At shear stresses immediately above the critical stress for breaking of individual particle bonds, "surface" or "particle" erosion occurs. When the applied hydraulic stress is increased to the level where turbulent eddies impinge on and break small elements from the bed, "significant" erosion occurs. Significant erosion rates are much higher than particle erosion rates. When the applied hydraulic stress is increased to the level where it exceeds the bulk shear strength of a deposit, "mass" or "bulk" erosion occurs. This latter type of erosion instantaneously suspends bed material to the depth where the deposit strength equals the applied stress.

b. Particle cohesion requires interparticle collision. There are three basic mechanisms for collision: Brownian motion, flow shear due to turbulence, and settling of particles at different speeds, or differential settling (Hunt 1980). Out of these, shearing in the fluid column, which is prevalent throughout the tidal cycle except at slack water, produces the strongest interparticle bonds. Brownian motion is important in high-density suspensions, whereas at times of slack water as well as during the period immediately preceding slack water when rapid settling is occurring, differential settling plays an important role (Krone 1972).

c. At very low concentrations, e.g. ~100 mg/l or less, interparticle collision frequency is restricted by the dearth of particles in suspension. Particles settle more or less independently, and the settling velocity shows no significant dependence on concentration. At higher concentrations, up to ~3,000-5,000 mg/l, aggregation is enhanced with increasing concentration, and the settling velocity varies with  $m^{\text{th}}$  power of concentration, with  $m$  ranging from ~0.8 to 2, with a typical value of 1.3. At even higher concentrations,

particularly in excess of ~10,000 mg/l, the settling velocity begins to decrease with increasing concentration as aggregates form a continuous network through which pore water must escape upward for settling to occur. This is referred to as hindered or zone settling. The term fluid mud is often used to describe a high-concentration (>10,000 mg/l) suspension that characteristically exhibits the hindered settling behavior (Krone 1962).

d. Aggregates of sediment in the clay- and silt-size range typically behave as bed material load (however not as bed load), while very fine material, e.g., derived from biogenic sources, often behaves as wash load, not being represented in the bed.

e. Inasmuch as cohesive aggregate properties (e.g., size, density, and shear strength) depend on the type of sediment-fluid mixture as well as the flow condition itself, particle size has a different meaning here than in the case of cohesionless sediment, since aggregate size is not an easily characterized quantity. The critical shear stress for erosion, or more accurately, the cohesive bed shear strength with respect to erosion, depends on the mode of formation and degree of consolidation of the bed (Mehta et al. 1982). Consequently, Shields' (1936) relationship between the critical value of the entrainment function  $\Theta_{cri}$  and the roughness Reynolds number, is not applicable to particles of sizes less than ~40  $\mu\text{m}$  (see also Figure D-1 and Paragraph D-3). It becomes essential to conduct laboratory erosion tests to evaluate the bed shear strength for a given mud-fluid mixture (Mehta et al. 1982; Parchure 1984).

f. The process of cohesive sediment deposition and erosion are interlinked through bed consolidation. Rates of deposition and erosion in turn determine the rate of horizontal transport in suspension. In a tidal estuary, these processes are characteristically cyclic in nature; their interrelationship is schematized in Figure D-2 (Mehta et al. 1982). Suspension transport interacts with the bed through tide-controlled, time-dependent, deposition-consolidation-erosion process. The thickness and density of the deposit

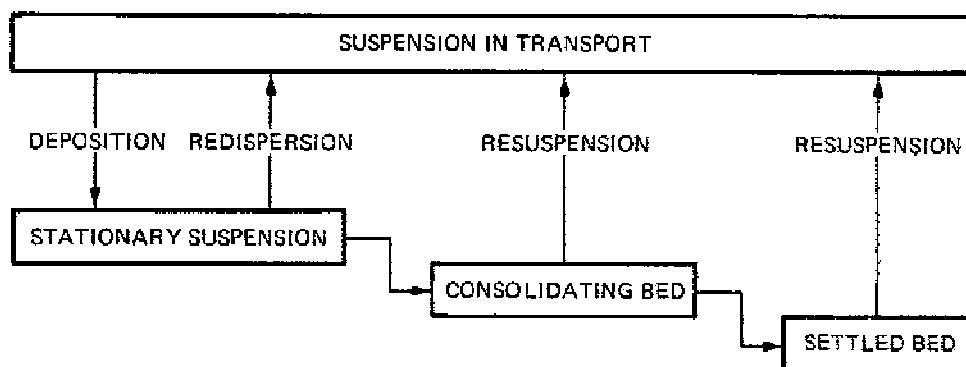

Figure D-2. Schematic representation of the physical states of cohesive sediment in estuarial waters (from Mehta et al. 1982)

respond to rates of deposition and erosion, and the deposit is continually undergoing consolidation. The "bed" level changes throughout the tidal cycle; and in most cases, precise prediction of bed level changes in an environment where both deposition and erosion occur over a tidal cycle requires numerical modeling of the governing equations of continuity, momentum, and mass transport (Ariathurai and Krone 1976; Hayter and Mehta 1984). In Figure D-2 it is indicated that settling of sediment (during times of decelerating flows and at slack water) results in a stationary suspension at the bottom. In this type of high-concentration suspension, hindered settling occurs; and there is, by definition, no horizontal transport (Parker and Kirby 1982). The deposit then forms a bed through settling and consolidation. During consolidation (and gelling), upward escape of the pore water occurs, the bed density increases, and physicochemical changes occur within the bed as the deposited aggregates are crushed slowly under overburden. A settled or fully consolidated bed eventually results. In such a bed, bed properties do not alter with time. Relatively thin deposits, on the order of a few centimetres thickness, consolidate in a week or two, but thick deposits may remain underconsolidated for months or even years.

D-5. Impact of Flow and Geometry. Flow and sedimentary boundary conditions are critically important in governing estuarial sediment transport. At the mouth, tidal forcing is determined by the open coast tide characteristics as well as the geometry of the mouth itself. Thus, for instance, the type of sediment in the mouth area is contingent upon the properties of the sediment discharged through the river as well as the nature of open beach deposits. At the upstream end, beyond the influence of tides, the river discharge hydrograph and sediment inflow are key factors. Within the estuarial reach, runoff, direct precipitation, and bank erosion by currents and waves can be significant factors that contribute to the overall sedimentary regime.

a. Currents broadly divide the estuarial sedimentary environment into three categories: predominantly erosional, predominantly depositional, and mixed. Deposition-dominated environments include flood and ebb deltas near the mouth, shoal areas within the estuary including natural and dredged navigation channels, and basins including ports and marinas.

b. Sites where erosion is predominant tend to be localized in comparison with sites of deposition, although sometimes large previously deposited shoals disintegrate in the absence of sediment supply.

c. In a mixed deposition/erosion environment in which net scour or shoaling is small, as would occur if the regime were in a state of "live bed" equilibrium, the rates of deposition and erosion can be high individually, and these would cause significant "to and fro" transport of sediment during a tidal cycle. On the other hand, in mild to moderate tidal environments, the rates of sediment transport under "normal" conditions may be small, but can be enhanced by as much as two to three orders of magnitude during episodic events including storms. In such an environment, sediment transport is not wholly tide-controlled, and it becomes essential to obtain long-term measurements of

the rates of sediment transport in order to characterize seasonal and episodic influences on the physical regime.

d. The role of waves superimposed on tidal currents can be quite important. Shallow- and intermediate-depth water waves provide a critically important mechanism for incipient motion, resuspension of bottom sediment, and the formation of fluid mud layers. The sediment is then advected by the tidal currents. The often observed measurable rise in sediment transport rates during storms is quite often due mainly to bottom erosion by wave-induced oscillatory velocities since tidal velocities do not always increase significantly during storms unless a storm-induced surge occurs. Wave breaking at the banks can also cause a measurable increase in sediment concentrations and subsequent transport rates.

e. Aeolian transport is usually ignored in typical estuarial transport calculations. In certain areas, such as small basins, wind-blown material can form a significant fraction of the total deposit, particularly where sediment transport rates in the water body are not high. The degree of susceptibility of the surrounding terrain to wind-induced erosion will be a contributing factor independent of tides. However, exposure of terrain is somewhat dependent on tides; e.g., for large-amplitude tides, a greater length of beach is exposed to wind effects during low water.

f. The rise of sea level relative to land has contributed to measurable bank erosion in some estuaries and should be considered when comparing bathymetric surveys taken at widely different times (Krone 1979).

g. The impact of estuarial geometry on sediment transport is associated with the effect of geometry on flows that transport sediment. For example, it is quite common to find relatively well-defined flood- and ebb-dominated channels with consequent implications for the direction of sediment transport. Furthermore, deep, dredged channels often are natural sites for sedimentation as are basins constructed along estuarial banks. Until recent times, structural means to train or control estuarial flows or shoaling/scour were often employed as and when necessary, sometimes without regard to its implications on overall estuarial stability. In some estuaries, e.g., the Mersey in England, this has resulted in severe problems for navigation and berthing (Bruun 1978). Diversion of tributary flows for agricultural or urban uses can also have deleterious effects, both with respect to sedimentation as well as water quality (McDowell and O'Connor 1977).

h. The null zone is often the area of highest concentrations of suspended particulates and rapid sediment accumulation (shoaling) (Inglis and Allen 1957). Several processes account for this. Sediments that settle into the lower part of the water column are transported upstream by tidal-residual circulation to the null zone. Sediments scoured from the bottom and transported on the flood tide and then deposited on the ebb tide phase are tidally pumped toward the null zone. At the limit of salinity intrusion (usually a relatively short distance upstream from the null zone), scour can occur on the ebb tide phase, encouraged by freshwater deflocculation of consolidated muds.

i. A constriction within a tidal flow will cause a near-bottom tidal-residual convergence zone that can trap sediments. Constrictions have been associated with shoal areas, as an example, inner and outer shoals associated with arrowhead jetties.

D-6. Sediment Characterization and Analysis. Characterization provides the basic information for identifying transport processes. Characterization tests for coarse- or fine-grained sediment depend on the nature of sediment. It is common to find sediment from a site to consist of a range of materials from coarse size to clay size. In such a case it usually becomes necessary to separate the coarse and fine fractions and analyze them separately.

a. For coarse sediment it is typically useful to evaluate particle size distribution or, preferably, settling velocity distribution; material density and bed porosity; and, sometimes, the angle of repose.

b. Size distribution for coarse sediments is customarily obtained through sieve analysis in terms of selected sieve sizes. It is preferable to characterize sediment by its settling velocity, which is more basic to sediment transport. Since the drag coefficient of a particle in the fluid varies, in general, with particle size, shape, and density, there is no unique relationship between size and settling velocity; and it is somewhat speculative to relate particle size to settling velocity through plots or nomograms in which the particle shape must typically be assumed. Details on particle size and settling velocity measurements as well as material density and bed porosity are found elsewhere (Vanoni 1975). The angle of repose is a basic property associated with bank stability as well as incipient grain movement (Lane 1955; Mehta and Christensen 1983).

c. For cohesive sediment, the problem of characterization is more complex than that for coarse-grained material, because sediment aggregate properties depend on the type of sediment, the fluid, and the flow condition itself.

d. For characterizing the fine-grained sediment, it is recommended that the following be specified:

(1) Grain size distribution of dispersed sediment using, for example, the standard hydrometer test (ASTM 1964).

(2) The relationship between the median settling velocity and the suspension concentration of the flocculated sediment (Owen 1976).

(3) Clay and nonclay mineralogical composition through X-ray diffraction analysis (Grim 1968).

(4) Organic content (Jackson 1958).

(5) The cation exchange capacity, which is a measure of the degree of cohesion of the clay (Grim 1968).

e. For characterizing fluid in regard to fine-grained sediment, it is recommended that the following conditions be specified:

(1) Concentrations of important cations (e.g., sodium (Na<sup>+</sup>), calcium (Ca<sup>++</sup>), and magnesium (mg<sup>++</sup>)) and anions (e.g., chlorine (Cl<sup>-</sup>) and sulfate (SO<sub>4</sub><sup>-</sup>)).

(2) Total salt concentration.

(3) pH.

(4) Fluid temperature during measurements as well as in laboratory experiments for determining the rates of erosion and deposition.

Items (1), (2), and (3) can be determined through standardized chemical analysis procedures.

f. Recognizing that sodium, calcium, and magnesium are three comparatively more abundant and influential cations, the sodium adsorption ratio (SAR) is found to be a convenient parameter for characterizing the influence of fluid chemistry on cohesive sediment transport behavior. This parameter is defined as

$$\text{SAR} = \frac{[\text{Na}^+]}{\left\{ \frac{[\text{Ca}^{++}] + [\text{Mg}^{++}]}{2} \right\}^{1/2}} \quad (\text{D-3})$$

where [ ] indicates ionic concentration in milliequivalents per liter. SAR is essentially a measure of the degree of abundance of sodium relative to calcium and magnesium.

g. Inasmuch as consolidation increases bed density, it is important to obtain representative in situ cores for determining the depth-distribution of the density (bulk and dry) of the bed. This information enables a conversion between deposition and erosion of sediment mass per unit time and the corresponding changes in the suspension concentration (mass per unit volume), and gages the hydraulic shear strength of the sediments.

h. In studies in which dissipation of fluid energy within the bed plays an important role, e.g., wave-mud interaction, it is essential to evaluate the rheological properties, the most important one being the viscosity, which has been found to be related to sediment concentration in an approximate manner (Krone 1963). Muds typically exhibit a non-Newtonian rheology. Thus it becomes necessary to specify parameters in addition to viscosity. Most commonly this includes the Bingham yield stress, for a comparatively simplified rheological description. The dynamic behavior of muds under wave-induced loading suggest a visco-elastic response.



i. The characterization of sediment is necessary to aid in the identification of transport and deposition processes. Preplanning for specific project data collection programs is essential so that the proper type, quantity, and data analysis can be conducted. The preceding and following paragraphs describe various field tests and sediment analyses, which may or may not be required. The amount and type of data and required procedures and tests should be determined during the project planning stage. Too much or too little data could be costly and detrimental to the project. These chapters and appendices provide general guidance; specific guidance can be found in Appendix A or through the Hydraulics Laboratory, WES.

D-7. Transport Parameters. The movement of sediment is sensitive to flow speed and direction, and it is particularly important to characterize the flow regime including the influences of salinity, geometry, and wind and related factors for a comprehensive evaluation of the overall sediment transport regime. Errors in correctly specifying the flow field will result in corresponding discrepancies in the prediction of the rate and direction of sediment transport. In a water body with large longitudinal and lateral dimensions, inadequate specification, for instance, of the flow direction, can lead to significant errors in the prediction of sites of sedimentation, particularly if the sediment is fine-grained, as a result of the relatively long distances over which the sediment is advected over each flood and ebb.

a. Particle settling velocity is both an important sediment characterizing parameter as well as deposition-related parameter. The critical shear stress is the important erosion-related parameter. Field and laboratory procedures for evaluating these and associated parameters, where cohesionless sediment transport is concerned, are well-documented in literature (Owen 1970; Vanoni 1975). It must be recognized that, as a result of estuarial variability, it is essential to obtain adequate prototype measurements for the rates of sediment transport in each site-specific investigation. Use of sediment transport formulas without adequate calibration of the formulas may lead to major errors in transport rate prediction.

b. Cohesive sediment transport processes that require parametric characterization include settling and deposition, consolidation, and erosion (Teeter, Hodges, and Coleman 1987). This information, coupled with formulations for the diffusion coefficients for sediment in suspension, forms the basis for predictive mathematical modeling for evaluating the temporal and spatial description of the suspended sediment concentration, given the flow field and boundary conditions (Hayter and Mehta 1984).

c. Settling is principally characterized by the relationship between the median settling velocity and suspension concentration:

$$W_s = f(C) \quad (D-4)$$

where  $W_s$  is the median (by weight) settling velocity and  $C$  is the suspension concentration (dry mass of sediment per unit volume of suspension). There are basically four procedures for evaluating this relationship, each

under a specific set of conditions and, therefore, yielding results which are peculiar to those conditions. These procedures are as follows:

(1) Tests in a laboratory settling column. This involves starting with an initial, flocculated suspension of known concentration in a well-shaken column, allowing the material to settle subsequently under quiescent conditions, and sampling the suspension at selected elevations and time (ASTM 1964; Hunt 1980; Krone 1962).

(2) Highly specialized tests in an appropriate laboratory flume. Sediment is initially suspended at a high flow velocity and then allowed to deposit at reduced velocity. Suspension concentration is sampled at selected times after deposition begins. The rate of aggregation is high, particularly in the beginning, provided the suspension concentration is greater than 1,000 mg/l (Krone 1962; Mehta and Partheniades 1975; Teeter and Pankow 1989b).

(3) Use of in situ settling tube. This tube, designed originally by Owen (1971), allows for onsite measurements. The "Owen tube" is lowered from a boat for collecting the suspension sample. In water it is held in a horizontal horizontal attitude. When drawn out of water, it pivots vertically, and the sediment within the suspension begins to settle. Subsamples of the suspension are withdrawn at selected times from the tube, and the settling velocity determined in a manner similar to that using a laboratory settling column. By performing the settling test almost immediately following sample withdrawal from the water body, the aggregates are presumed to remain unaltered in composition. Measurements obtained through this procedure are sometimes found to yield settling velocities as much as an order of magnitude larger when compared with corresponding measurements in laboratory settling columns. Relationships obtained between settling velocity and concentration determined from field tests also include variability in sediment characteristics caused by variations in such variables as flow and inflow conditions and water chemistry (Teeter and Pankow 1989a).

(4) Comparison of measured suspended sediment concentration profiles (depth-concentration variation) with analytic prediction. The unknown in the latter is the settling velocity, which can be evaluated by matching the measured and theoretical profiles. In some relatively "well-behaved" situations, this procedure results in acceptable values of the settling velocity (Mehta et al. 1982; O'Connor and Tuxford 1980).

d. For prototype application, the use of the in situ tube is the preferred method of measurement of settling velocity. Extensive measurements of this nature have, for instance, been obtained in the Thames Estuary in England (Burt and Stevenson 1983). Comparison between measured and theoretical concentration profiles, where feasible, can yield realistic values of the settling velocity (Mehta et al. 1982). Laboratory flume or settling column tests should be used for supplementary and/or confirmatory evidence. A major difference between flume and settling column test results is that, while deposition occurs under continued aggregation in the flume under flow, settling in a

column occurs in the absence of shearing rates and aggregation proceeds very slowly.

e. The rate of deposition depends on the rate at which the fraction of the settling sediment deposits, the remainder consisting of aggregates that break up near the bed under the action of bed shear stress and/or are re-entrained. The reentrained pieces may reaggregate and settle again, some of those will deposit, and so on. Deposition is expressed as

$$\frac{dm}{dt} = - W_s \bar{C} \left( 1 - \frac{\tau_b}{\tau_{cd}} \right); \tau_b < \tau_{cd} \quad (D-5)$$

where

- m = mass of suspended sediment per unit bed area over the depth of flow
- t = time
- C = depth-averaged suspension concentration
- $\tau_b$  = bed shear stress
- $\tau_{cd}$  = critical shear stress below which all initially suspended sediment deposits eventually

For a particular sediment,  $\tau_{cd}$  can be evaluated from laboratory flume experiments (Krone 1962). For a uniform (narrow primary particle size distribution) sediment, single values of  $W_s$  and  $\tau_{cd}$  will suffice. For a graded sediment (e.g., a typical mud with a relatively wide range of sizes from coarse silt to fine clay),  $W_s$  and  $\tau_{cd}$  will have corresponding wide ranges. These can be determined by fractionating the sediment into two or three parts in terms of size, and evaluating  $W_s$  and  $\tau_{cd}$  for each fraction through flume deposition tests. On the other hand, the unfractionated sediment will exhibit a composite behavior whereby above a certain characteristic value of the bed shear stress (Teeter and Pankow 1989b), a fraction of the total initially suspended sediment will not deposit, even in the long run (Mehta and Partheniades 1975), as a consequence of the occurrence of ranges of  $W_s$  and  $\tau_{cd}$ , instead of single values of these two parameters.

f. Consolidation of freshly deposited mud is accompanied by release of excess pore pressure, decrease in total bed thickness, corresponding increase in bed density and physicochemical changes associated with interparticle bonds, including gelling. Following bed formation, gelling is complete in about a day (Krone 1983).

g. From the perspective of estuarial sediment transport, the decrease in bed depth accompanying consolidation is not always of critical importance. Of much greater importance are density increase and physicochemical changes, because these in turn control corresponding changes in the bed shear strength with respect to erosion (Mehta et al. 1982). For relatively thin beds, on the order of a few centimetres in thickness, consolidation, in the absence of additional deposition, is practically complete in a period on the order of one or two weeks, and the rate of bed deformation becomes small in comparison with

the rate immediately following bed formation. Bed properties including density and erosional shear strength become nearly invariant with further passage of time and a stabilized, or settled, bed (Figure D-2) results.

h. Investigators have found an approximate relationship between the bed resistance to erosion and bed density, specific to the type of sediment and fluid used (Migniot 1968; Owen 1971; Thorn and Parsons 1980; Teeter 1987). Given  $\tau_s$  the critical shear stress for erosion and  $\rho$ , the dry density, the relationship is of the form

$$\tau_s = \alpha \rho^\beta \quad (D-6)$$

where  $\alpha$  and  $\beta$  must be determined experimentally.

i. The rate of surface erosion is obtained from

$$\frac{dm}{dt} = M \left( \frac{\tau_b - \tau_s}{\tau_s} \right); \tau_b > \tau_s \quad (D-7)$$

where  $M$  is an empirical erosion rate constant (Ariathurai and Arulanandan 1978; Mehta et al. 1982). Note that excess shear stress,  $\tau_b - \tau_s$ , is an important rate-determining parameter. In general,  $M$  and  $\tau_s$  must be evaluated through erosion experiments in flumes. It should be noted that  $\tau_s$  changes with depth of erosion into the bed. Mass erosion to the depth of the bed where shear strength equals the applied stress occurs with increasing stress.

D-8. Causes of Sediment Deposition. As evident from Equation D-5, the rate of sediment mass deposition  $dm/dt$  increases with increasing settling velocity  $W_s$  and with suspension concentration  $C$ , and decreases with increasing bed shear stress  $\tau_b$ , given  $\tau_{cd}$ . Likewise, Equation D-7 indicates that the rate of sediment erosion increases with increasing  $\tau_b$  for given magnitudes of  $\tau_s$  and  $M$ . This means the instantaneous value of the concentration  $C$  (obtained by integrating the rate of erosion over the duration of erosion) increases with  $\tau_b$  as well. It follows from Equation D-5 that the mass of sediment deposited depends on the availability of entrained sediment, its settling velocity, and flow condition as reflected primarily in the bed shear stress. This type of reasoning is generally applicable to cohesive as well as cohesionless sediment.

a. A deposition-dominated environment is characterized by a region of relatively low bed shear stress in which the rate of supply of sediment to the bed well exceeds the rate of removal by erosion. Typical sites for deposition include flood and ebb deltas near the mouth, navigation channels, the region of maximum turbidity, harbors, and small basins (Ippen 1966; Mehta et al. 1982).

b. In the absence of significant and rapid natural or man-made changes, estuaries tend to be in a state of quasi-equilibrium as far as the

hydrodynamic and sedimentary processes are concerned. This means that, superimposed on the annual cycle of variation of tides, freshwater flows, salinity intrusion, and sediment transport, longer period variations in the physical regime occur. Slow filling up of the existing deep channel or thalweg, coupled with scouring of a new channel elsewhere, may occur over a 10- to 20-year period, as, for example, occurs near the mouth of the Hooghly Estuary in India (Calcutta Port Commissioners 1973; McDowell and O'Connor 1977). Many estuaries are slowly filling with sediments. It is therefore critically important to understand the long-term estuarial behavior through an adequate monitoring program, particularly one involving extensive bathymetric surveys.

D-9. Consolidation. Consolidation is the volume change in sediment material with time. The fully consolidated volumes of fine sediments are often only a fraction of their initial deposited volumes. Coarse sediments do not consolidate under estuarine conditions; the discussion that follows deals with fine or cohesive sediments. Consolidation should be considered under the following circumstances: when evaluating sediment dispersal resulting from dredging or originating from a disposal site; when sizing confined or unconfined disposal areas for dredged materials; or when calculating dredging volumes or masses.

a. The formation of fluid muds can alter the transport mode of fine-grained sediments and therefore can be important to sediment transport and shoaling analyses. Fine-grained material with high moisture or low bulk density has relatively low shear strength, and can flow under the effects of gravity or the overlying flow. Observations of fluid mud flow have been made using radiotracers. The consolidation processes of stationary fluid mud are important to bed hydraulic shear strength and to net deposition in tidal flows. Where the thickness of fluid mud layers becomes substantial (say a foot or more), it is often referred to as "fluff." Such fluid mud layers often collect in navigation channels and can achieve thicknesses of several feet, as in the Savannah Estuary (Krone 1972). Fluid mud layers have acoustic properties resembling consolidated sediments even though they do not impede navigation. It is likely that large sums of money have been expended to "remove" fluid mud layers. Better rapid bottom characterization techniques are needed and are currently being investigated in the Dredging Research Program at WES. Consolidation affects the ultimate volume and rate of volume change in fine-grained dredged material.

b. The amount of consolidation that disposed dredged material will undergo can be predicted by settling tube or accelerated consolidation tests and models. Reference should be made to Montgomery (1978) or to Cargill (1983 and 1985). Dredged material can be observed in large laboratory columns for a month or more to determine its final settled condition, as one method of testing. Similar zone- or column-settling tests can be performed on finegrained sediments to determine settling characteristics over a range of high suspension concentrations. Tests are performed by making serial dilutions of sediments with native water and observing settling behavior in smaller clear jars or columns. Once the relationship between concentration and settling rate is determined, further analyses can be made. By plotting settling rate versus concentration on log-log paper, the concentration at which sediments begin to

behave as a deposit and how quickly concentration and strength increases can be identified. If self-weight consolidation modeling is to be carried out, special controlled-strain consolidation testing is required. Controlled-strain consolidation testing is performed at the WES Geotechnical Laboratory.

D-10. Physical Models. Physical hydraulic models are scaled representations of the prototype. They are adjusted to reproduce the important characteristics of estuarine flow. Physical hydraulic models can be important tools in sedimentation analysis of estuaries, including sedimentation patterns. Physical hydraulic modeling should be considered as one component of a program to study sedimentation if three-dimensional flow effects are known or suspected to be important. Chapter 3 described their use in hydrodynamic evaluations. Much of the physical modeling of estuaries in the United States is performed at the WES Hydraulics Laboratory and a compilation is provided in Appendix F. This section will briefly describe the use of physical hydraulic models in sedimentation studies.

a. Scales. Scale modeling of sediment transport is difficult because of scale effects and conflicting scaling requirements for the various important processes. For noncohesive sediments, compromises in scaling requirements can usually be devised by setting the time scale empirically, but considerable modeling skill is required to conduct and interpret the tests. For cohesive sediments, scale modeling is made even more difficult by the inability to scale down sediment aggregation and settling velocity. The most common practice has been to use noncohesive model sediments as tracers and apply considerable intuition and judgment to the results before drawing conclusions.

b. Processes. Physical hydraulic models are three-dimensional representations of the prototype system and have been successfully used to predict tidal currents, circulation, riverflows, salinity distributions, and dispersion processes. Many or all of these processes influence sedimentation. The ability of physical models to represent the flows in complex geometry makes them useful tools. Physical hydraulic models have been successfully incorporated into hybrid model studies as discussed in Paragraph D-13. Because they are real, physical representations, physical hydraulic models display system dynamics in a manner that can be readily assimilated by both modeler and lay persons. The initial cost for a physical hydraulic model is somewhat higher than for other methods, but they can be operated and maintained for years and serve many studies over their lifetime. Physical hydraulic models can simulate long periods of time, spring-to-neap cycles, or hydrographs.

c. Test Procedures. During model verification, hydraulic and salinity adjustments are made first. Sedimentation is adjusted to shoaling volumes computed from a series of prototype hydrographic surveys. Methods are developed during model adjustment to introduce, distribute, and collect model sediments. Sedimentation rates are often scaled against maximum or total values. A base test is sometimes performed, but often the verification tests serve this purpose. Plan tests are then run to assess the impacts of the test modifications on sedimentation. Model sediment tracers are commonly

used in fixed-bed physical models to trace the paths that eroded material will follow and to develop shoaling distribution changes caused by estuarine modifications.

D-11. Analytical Models. Analytical models are closed-form mathematical solutions for sediment transport rate of deposition. Data required to "drive" analytical models come from field surveys, another model, or assumed conditions. Analytical models are considerable simplifications of estuarine sedimentation processes but are useful for such tasks as screening, checking the reasonableness of other methods, and identifying important processes. The following are some examples of analytical models.

a. Treatment of Data. Analytical models are a method of treating prototype data. Time series velocities and concentrations can be integrated using assumed critical shear stresses to estimate depositional flux or net deposition. Equations such as D-4 or D-7 can be used for this purpose and form the basis for a closed-form mathematical solution.

b. Interpretation of Field Data. First, currents are used to calculate bed shear stress  $\tau_b$  using Manning's or some other expression. Note that only an approximate estimate of shear stress can be expected from such a procedure. Using a critical shear stress for deposition ( $\tau_{cd} \sim 0$  to 0.15 Newtons per square metre), deposition probabilities  $P$  are calculated over the portion of the data when  $\tau_b < \tau_{cd}$  where

$$P = 1 - \frac{\tau_b}{\tau_{cd}} ; \tau_b < \tau_{cd} \quad (D-8)$$

as described in Equation D-5. The product  $PW_sC_b$  is integrated over that portion of the tide curve, where  $C_b$  is the near-bed concentration. Erosion is estimated by integrating  $M[(\tau_b/\tau_s) - 1]$  over that portion of the tide curves when bed shear stress is greater than the threshold value for bed erosion  $\tau_s$  as in Equation D-7. The rate constant  $M$  has been reported to be from 0.0002 to 0.0020 kilograms per square metre per second (Hunt 1981). Deposition and erosion can then be summed to a net bed change value.

c. Flux Analysis. An alternate or supplemental analysis to that of the last section is horizontal suspended flux analysis using prototype data. Flux is the movement of material and has the units of mass per time. Horizontal flux analysis makes no assumption about deposition characteristics of sediments. Deposition or erosion can be inferred from longitudinal gradients of sediment flux using this method. Inglis and Allen (1957) presented examples and methods for computation. Measurements of currents, salinities, and suspended sediment concentration over depth and over a tidal cycle can be used to calculate the total fluxes at a station by integration over time and space (Teeter 1988). More information can be obtained from the data by decomposing sediment and salinity fluxes to identify dominant transport processes, as described in D-11e.

d. Suspended Concentration Analysis. A useful approach to the analysis of data collected over a tidal cycle, and at several depths and stations, is to reduce the data to a small number of parameters that represent important transport information (Teeter 1989). Sediment concentration, as well as velocity and salinity, data can be so reduced by a series of spatial and temporal averagings into a combination of tidal-mean and fluctuating depth-mean components, as well as vertical deviations from the depth-means. For example, at some time  $t$  and station depth  $z$ , an individual datum of suspended sediment concentration  $C$  can be decomposed into components thus:

$$C(z,t) = C_o + Cov(z) + C_i'(t) + C_{iv}'(z,t) \quad (D-9)$$

where  $\bar{C}_o$  is the depth-averaged tidal-mean concentration,  $Cov(z)$  is the vertical deviation of the tidal mean from the depth mean,  $C_i'(t)$  is the depth mean instantaneous concentration component, and  $C_{iv}'(z,t)$  is the vertical deviation of the instantaneous component from the depth mean. Then by root-mean-square averaging in the remaining dimensions four components are formed. They include the depth-averaged time-mean concentration,  $C_o$ , the vertical deviation from the depth mean,  $Cov$ , the depth-averaged fluctuating component,  $C_i$ , and the depth deviation in the fluctuating component,  $C_{iv}$ . A similar approach can be used to examine lateral variations in transport.

e. Sediment Flux Components. More information on the processes responsible for estuarine suspended sediment transport can be obtained by decomposing fluxes into components. Multiplying suspended sediment concentrations by velocities and decomposing the resulting fluxes into components, as described earlier for sediment concentration, identify the relative magnitude of important processes or mechanisms including transport by net flow, vertical circulation, and tidal pumping. Net flows result from freshwater flows, from long-period (subtidal) oscillations, and from tidal asymmetry. Transport by vertical circulation (vertical shear in the mean flow) is often associated with density effects in estuaries. Vertical circulation is usually at least partially responsible for the maintenance of turbidity maximums and for high-shoaling rates in estuarine mixing zones. Tidal pumping is an advective transport process that operates in the direction of reduced concentrations. For instance, if overall suspended sediment concentrations are higher on the flood than on the ebb tide, transport by depth mean tidal pumping in the upstream direction is indicated. Further, if near-bed suspended sediment concentrations are higher on the flood than on the ebb tide (typical), and/or if the near-bed velocities are higher on the flood than on the ebb tide (also typical), transport by tidal pumping at depth is indicated. Decompose tidal-cycle suspended sediment fluxes into components or correlations thus:

$$\text{Flux of } C = A(\bar{U}_o\bar{C}_o + \overline{U_i C_i} + \overline{U_{ov} Cov} + \overline{U_{iv} C_{iv}}) \quad (D-10)$$

where  $A$  is cross-sectional area at the sampling point.  $\bar{U}_o\bar{C}_o$  is the product of depth and time mean values of velocity and concentration and represents



sediment transport by depth-mean residual flows.  $\overline{U_i C_i}$  is the correlation between depth-mean velocity and sediment concentration fluctuation  $\overline{UovCov}$  is the transport associated with steady vertical shear and concentration deviations.  $\overline{UivCiv}$  represents transport by correlations between fluctuations in velocity and concentration deviations.  $\overline{U_i C_i}$  and  $\overline{UivCiv}$  comprise tidal pumping. The first two terms on the right-hand side of Equation D-10 are depth mean, and the last two arise from vertical effects and circulation. Similar analyses can be carried out for the lateral direction.

f. Depositional Models. Zero-dimensional (in the spatial domain) models can be applied to basins or to channels with relatively steady and uniform flows. A slightly more complex model incorporating tidal prism input could be applied to an estuary as a whole or to tidal basins. A starting point for one such model is the depth- and tidal-averaged deposition equation for fine sediments:

$$H \frac{dC}{dt} = \gamma \frac{dH}{dt} = - \sum_i P_i W_{si} C_{bi} \quad (D-11)$$

where  $H$  is depth and  $\gamma$  is the unit weight of the bed sediments. The subscript  $i$  indicates a settling class of sediments. The solution for this equation for a single component or class after substitution of an expression relating near-bottom to depth-mean concentration is

$$\frac{C}{C_0} = \exp \left\{ -tPW_s \left[ \frac{1}{H} + \frac{W_s}{K_z (1.25 + 4.75P^{5/2})} \right] \right\} \quad (D-12)$$

where  $C$  and  $C_0$  are the depth mean and initial or inflow depth mean concentrations, respectively, and  $K_z$  is the depth-averaged vertical diffusivity. The last term in this expression vanishes as the suspension becomes more vertically well-mixed.

D-12. Numerical Models. Most numerical modeling of estuaries and estuarine sedimentation within the US Army Corps of Engineers is done at the WES Hydraulics Laboratory. A variety of one-, two-, and three-dimensional models have been applied. Multidimensional unsteady numerical models for sediment transport began to be developed in the mid-1970's. A two-dimensional (in the horizontal plane) numerical sedimentation model is included in the Corps' TABS-2 modeling system (Thomas and McAnally 1985). TABS-2 is available to qualified users Corps-wide. Training on the TABS system is available at WES. An example numerical modeling investigation including sediment transport (using the two-dimensional, laterally averaged model LAEMSED) is given in Appendix C.

a. Model Processes. Numerical sediment models are transport models with nonconservative bed interaction terms. Sediments are numerically

transported by advective currents and by diffusion. Sediment models require that currents be supplied by a hydrodynamic (usually numerical) model. Interactions between suspended sediments and the bed are governed by process equations in sediment transport models. Coarse sediment-bed interaction terms usually depend on the difference between sediment in transport and the competency of the flow to transport material. Fine sediment-bed interaction terms consist of process description for erosion and deposition similar to Equations D-4 and D-7. Bed structure or layering is usually modeled in some way to account for changes in density and shear strength with depth in fine sediments (Teeter and Pankow 1989c). Numerical sediment models are classified by their dimensions, by sediment type, and the equations that are solved.

b. Model Applications. Numerical models are the most advanced modeling method available for simulating sedimentation. Numerical models in general are limited to two dimensions, although three-dimensional models are currently (1989) under development and testing. Even so, numerical models contain vastly less geometric information than, say, a physical model. Also, the equations solved by numerical hydrodynamic and sediment models are simplifications or abstractions of actual behavior. Analyses suggested earlier to analyze sediment flux can also be used as a guide to select model dimensions, especially the need to include the vertical dimension. Numerical modeling, like other modeling methods, remains an art-science and successful application to real problems depends heavily on the skill, experience, and intuition of the model user.

D-13. Hybrid Models. Combining two or more models in a solution method is hybrid modeling. Hybrid models attempt to use the best modeling methods available available for each "part" of sedimentation problems: current structure and sediment transport. Hybrid sediment models or analyses use one modeling method for hydrodynamics and another method for the sediment predictions. The following are the most frequently used hybrid techniques, starting with the most rigorous.

a. Physical-Numerical. The physical-numerical hybrid modeling approach uses a physical model to predict currents and a numerical model to predict sediment transport. This approach has been successfully applied to a number of estuarine sediment problems at the WES Hydraulics Laboratory. Since current velocities are needed at a great many points for the numerical sediment model, a numerical hydrodynamic model is employed as an "interpolator" of the physical model results. The physical model can be used to generate boundary conditions for the detailed numerical mesh or grid of the sediment model.

b. Physical-Analytical. The physical-analytical hybrid modeling approach uses a physical model for currents and an analytical model to predict sedimentation. Velocities can be collected at various points in the physical model and converted to bed shear stress histories. Dye study results can also give indications of circulation and residence times between various areas. Physical model results can then be extended using appropriate analytical expressions such as Equations D-4 and D-7. Only limited spatial coverage can be obtained with this technique, and simplifying assumptions must be made

about the behavior of the sediments. This technique is useful when sedimentation is caused by some feature of the flow or of the residual circulation.

c. Numerical-Analytical. A numerical-analytical hybrid model uses a numerical model to predict hydrodynamics. Numerical hydrodynamic models are more costly to operate than numerical sediment models, but numerical sediment models can be significantly more costly to adjust and verify. The numerical-analytical hybrid technique avoids the costs associated with numerical sediment modeling, but at the expense of considerable rigor. The results from a hydrodynamic model can be used to address limited questions on sedimentation using analytical models. The shear stress at various points can be evaluated to predict deposition or erosion. Circulation and sources of sediments cannot be addressed. The analytical method can be applied only to a relatively small number of locations.

D-14. Field Data Requirements. All analyses depend on field data. Field data acquisition may be the most costly part of a sedimentation study. Required data can be grouped into system definition and behavior and boundary data. System definition includes the topography, sediment characteristics, and water level statistics. System behavior includes both synoptic tidal propagation, current structure, suspended sediment concentrations, and salinities and/or long-term records of water levels, currents, suspended sediment concentrations, salinities, and shoaling volumes. An evaluation should be made of the importance of meteorologic or hydrologic events, requiring records or samplings over an appropriate span of time. Boundary data includes freshwater inflows to the system, tidal information, and all other modeled state variables (salinity, sediment concentration, etc.) at the boundaries of the system (see Chapter 3). The following discussion is limited to sediment data requirements.

a. A good way to determine system behavior is to conduct a boat survey in which currents, salinities, and suspended sediment concentrations are collected at short time intervals (half hour) at several stations across several cross sections over at least one tidal cycle. Normally about two to five samples in the vertical are sufficient in depths of 50 feet or less. A greater number may be required in deeper water. Onsite determinations of settling velocity should be made at strengths of flow and possibly slack waters. If suspension concentrations are high ( $>1,000$  mg/l), vertical sampling resolution should be increased to ~2 metres or supplemented by continuous continuous turbidity or light transmittance profiles. Tides at several locations and supporting measurements or observations of winds or other factors are also required. If an intensive boat survey is not possible, fewer points can be sampled over longer (weeks) time periods, perhaps using automated equipment. Sampling at the boundaries of the area to be modeled is particularly important.

b. Bed sediment properties are required for system definition. Methods for sediment characterization were described in Paragraph D-6. Settling experiments in the field are preferred to laboratory tests, although conditions may require the latter. It is usually not practical to carry out

enough settling tests in the field to obtain sufficient spatial and temporal coverage. Supplemental information on settling can be obtained by the analysis of many vertical suspended sediment profiles and/or high-resolution non-dispersed particle size analysis (such as Coulter Counter analysis). Water column measurements of sediment concentration should include some measurements near or at the sediment bed-water interface. The presence of fluid mud should be checked using acoustic soundings, densimetric profiling, or low-disturbance coring devices. Shallow coring is also a good method of determining bed structures such as armoring, density differences, or layering.

c. It is very difficult to collect field data on all the important sediment properties. Classification by the methods described in earlier paragraphs may be useful in estimating sediment properties from existing data. Settling velocities, critical shear stresses for erosion and deposition, and the densities of fine-grained deposited material are properties that might require supplemental laboratory study. A series of laboratory settling tests on bed sediments should be run over a range of concentrations typical of the prototype to characterize this relationship. Further discussion on field data requirements for sediment transport modeling is given in Appendix B.

D-15. Notation. For the reader's convenience, notation used in Chapter 4 and Appendix D is listed here. Typical units have been included and are dependent upon the equation in which used.

$A$  = Cross-sectional area at the sampling point,  $m^2$

$C$  = Suspension concentration,  $mg/l$  or  $gm/m^3$

$C_b$  = Near-bed concentration,  $mg/l$

$C_i'(t)$  = Depth mean instantaneous concentration component

$C_{iv}'(z,t)$  = Vertical deviation of the instantaneous component from the depth mean

$C_o$  = Initial or inflow depth mean concentration,  $mg/l$

$C_{ov}(z)$  = Vertical deviation of the tidal mean from the depth mean

$\bar{C}$  = Depth-averaged suspension concentration,  $mg/l$

$\bar{C}_o$  = Depth-averaged initial tidal mean concentration,  $mg/l$

$d$  = Grain size,  $m$ ,  $mm$ , or  $\mu m$

$d_{gr}$  = Dimensionless grain size

$g$  = Acceleration due to gravity,  $m/sec^2$

EM 1110-2-1607  
15 Mar 91

H = Depth, m

$K_z$  = Depth-averaged vertical diffusivity,  $m^2/sec$

m = Mass of suspended sediment per unit bed area over the depth of flow,  $(Kg - m^2)/m$

M = Empirical erosion rate constant,  $kg/m^2/sec$

P = Deposition probability, nondimensional

SAR = Sodium absorption ratio

t = Time, sec or min

$u_*$  = Friction velocity, mm/sec

$\overline{U_i C_i}$  = Correlation between depth mean velocity and sediment concentration fluctuations

$\overline{U_i v_i C_i}$  = Transport by correlations between fluctuations in velocity and concentration deviations

$\overline{U_o C_o}$  = Product of depth and time mean values of velocity and concentration and represents sediment transport by depth-mean residual flows

$\overline{U_o v_o C_o}$  = Transport associated with steady vertical shear and concentration deviations

$W_s$  = Settling velocity, cm/sec or m/sec

z = Station depth, m

$\gamma$  = Unit weight of water, g/l or  $kg/m^3$

$\gamma_s$  = Unit weight of sediment, g/l or  $kg/m^3$

$\Theta$  = Entrainment function

$\Theta_{cri}$  = Critical value of the entrainment function

$\Theta_{crs}$  = Critical value for sediment suspension

$\nu$  = Kinematic viscosity of fluid,  $m^2/sec$

$\rho$  = Dry density, g/l or  $kg/m^3$

$\tau_b$  = Bed shear stress,  $N/m^2$

$\tau_{cd}$  = Critical shear stress for deposition, N/m<sup>2</sup>

$\tau_s$  = Critical shear stress for erosion, N/m<sup>2</sup>

## APPENDIX E

## EXCERPTS FROM "LESSONS LEARNED"

E-1. Introduction. The following list of lessons learned was compiled by the Committee on Tidal Hydraulics. The Committee selected 24 US Army Corps of Engineer navigation projects to develop case histories of a variety of projects and problems that have been investigated previously.

E-2. Background. There are several hundred Corps-constructed and -maintained navigation projects. These projects include deep-draft ship channels, small boat harbors, and intracoastal waterways. A number of these projects experience higher shoaling rates and therefore burdensome maintenance dredging requirements. One of the missions of the CTH is to provide consulting services to District offices on request to review problems and to make recommendations concerning possible causes and reduction/elimination of the problem.

E-3. Lessons Learned. The following list is a compilation of generic lessons learned from the estuarine projects reviewed by the CTH.

a. Dredged channels or harbor facilities in naturally shallow water usually will require frequent maintenance dredging.

b. Where possible, docks should be located in naturally deep water.

c. An increase in channel depth usually will allow greater penetration of the saltwater wedge, which will move the shoaling location upstream.

d. Either a decrease or an increase in freshwater inflow (due to upstream dam regulation or flow diversion) can alter the salinity characteristics of an estuary (increased intrusion length or increased stratification), which in turn can alter the location and rate of channel shoaling.

e. Increased river discharge (by diversion) can increase sediment load available for shoaling in the estuary.

f. Access channels and harbor areas off the main navigation channel should be streamlined to reduce eddies and deadwater areas where shoaling can occur.

g. Unconfined disposal of clean material usually has no adverse long-term effects on the biological population. The dredged channel and submerged disposal will be recolonized in 1 or 2 years.

h. Confined disposal will prevent the return of dredged material to the channel and reduce future channel shoaling.

i. Adjustment (sloughing) of dredged channel slopes can increase maintenance dredging for several years following construction, especially in sand-type bottom materials.

EM 1110-2-1607  
15 Mar 91

j. Isolation of the channel from sediment inflow by such training structures as dikes can reduce maintenance dredging.

k. Abandoning or relocation of projects should be considered when rapid shoaling prevents effective maintenance.

l. Change in bottom flow predominance can change volume and location of shoaling.

m. Piers on piling create eddies that increase shoaling rates of cohesive sediments.

n. Dredged disposal mounds should have relatively flat side slopes to reduce erosion. This will reduce return of material to active sediment system.

o. Suspended clay sediments can flocculate and cause shoaling with proper combination of salinity, water temperature, and flow conditions (e.g., low current velocities and slack-water periods). Flocculation is greatly accelerated by increases in the suspended sediment concentration.

p. Tide gates in secondary channels to divert ebb flow back to the main channel can aid flushing and reduce shoaling.

q. Controlled dredging and disposal practices can reduce the volume of sediment placed back in suspension. This will reduce the channel shoaling rate.

r. Expansions of harbor cross sections will reduce velocities, which can cause rapid shoaling.

s. Side channels, basins, and pier slips in estuaries are effective sediment traps.

t. Physical and/or numerical models can be very effective in studying a variety of problems, such as channel shoaling, tidal characteristics, salinity intrusion, flushing characteristics, channel alignment, training works, and flow diversions. (Various examples are cited in the preceding chapters and other appendices of this EM.)

u. Salinity behavior in many well- or partly mixed estuaries can result in a condition known as a turbidity maximum. This condition is caused by salinity-induced circulation patterns, resulting in a near-bottom flow predominance null point (no net flow in either direction). The zone of a turbidity maximum will often be subject to rather heavy shoaling; thus, this zone should be avoided when siting harbor facilities.

v. Since the inside of channel bends is usually an area of heavy shoaling, harbor facilities should be sited in the outside portion of bends.



w. Although ship simulators represent a new technology that was not available during any of the studies reported in these case histories, they are very useful in studies of channel alignment (e.g., effects of crosscurrents), dimensions (e.g., depth and width required for navigation safety), and bridge crossings (e.g., location and width of navigation openings).

x. Open-water disposal should be in a dispersive site (scour hole) where movement is out to sea, unless the site is intended to be retentive.

y. Channel alignment changes to minimize maintenance dredging should also consider alignment for safe navigation and avoid channel migration, which could undermine control structures.

z. Trench-placed riprap constructed in the dry before channel excavation is a cost-effective way to stabilize the final channel side slopes.

aa. Agitation dredging and in-channel disposal can be effective where strong ebb flow dominance exists.

bb. Some jetty systems may take years to reach equilibrium (100 or more years).

cc. Upstream bottom flow predominance can increase channel shoaling.

E-4. Summary. The preceding list of generic lessons learned was compiled by the CTH based on the review of 24 specific Corps navigation projects. The lessons learned should assist in problem avoidance before undertaking a project design or modification.

APPENDIX F

A SELECTED COMPILATION OF TIDAL HYDRAULIC  
MODEL INVESTIGATIONS

F-1. Introduction. This Appendix contains a selected compilation of tidal hydraulic model investigations that were conducted by the WES Hydraulics Laboratory (HL) and Coastal Engineering Research Center (CERC), for additional information and reference. The studies were selected from a much larger bibliography prepared by the USAE Committee on Tidal Hydraulics. The entries have been limited to those that are focused within and at the entrance of estuaries. Coastal design procedures and model investigations are included in other publications, such as: "Shore Protection Manual, 1984", in 2 volumes, by CERC, EM 1110-2-1614, "Design of Coastal Revetments, Seawalls, and Bulkheads" with Change 1, and EM 1110-2-2904, "Design of Breakwaters and Jetties."

F-2. The entries in this Appendix are separated into two main subdivisions:

- I. Hydraulic (or physical) Model Studies, and
- II. Numerical Model and Analytical Studies

The subdivisions were further organized by specific topics for ease of identification. The following prefixes are WES designations to describe the type of report:

- a. GITI = General Investigation of Tidal Inlets
- b. MP = Miscellaneous Paper
- c. SR = Special Report
- d. TM = Technical Memorandum
- e. TR = Technical Report

The following outline will also serve as an index to this Appendix.

F-3. Appendix F Outline and Index.

	<u>Page</u>
I. Hydraulic (or physical) Model Studies.....	F-3
A. Navigation Improvements.....	F-3
1. Inlets and Jetties	
2. Estuaries, Bays and Rivers	
3. Harbors	
4. Dredging and Dredged Material Disposal	

EM 1110-2-1607  
15 Mar 91

B.	Hurricane Studies.....	F-11
1.	Storm Surge Barriers	
C.	Hydrodynamic Research.....	F-14
1.	Salt Water Intrusion	
2.	Sedimentation	
3.	Currents, Tides, Dispersion and Flushing	
II.	Numerical Model and Analytical Studies.....	F-19
A.	Navigation Improvements.....	F-19
1.	Hybrid Models	
2.	Mathematical Model Studies	
3.	Ship Simulation Studies	
B.	Hurricane Studies.....	F-23
1.	Storm Surge Height	
C.	Hydrodynamic Simulations.....	F-24
1.	Salt Water Intrusion	
2.	Sedimentation Simulation	
3.	Currents, Tides, Dispersion and Flushing	
D.	Dredging Related Studies.....	F-27
1.	Dredged Material Disposal	

F-4. Availability. Corps Personnel: Most of the reports are available in either USAE District or Division libraries. If the library does not have a particular report, the librarian should contact the WES Technical Library for availability as an inter-library loan. Many of these reports are available through the National Technical Information Service (or NTIS), and the librarian can contact them at 5285 Port Royal Road, Springfield, Va 22161, or via electronic mail if available. Non-Corps and non-government individuals seeking any of these references should contact their local or public library for possible inter-library loan, or write to the NTIS at the above address.

Hydraulic Model Studies  
I. A. 1. Inlets and Jetties

Number	Date	Title
TM 2-417	Nov 1955	Plans for the Improvement of Grays Harbor and Point Chehalis, Washington; Hydraulic Model Investigation
TR 2-690	Aug 1965	Plans for Reducing Shoaling, Southwest Pass, Mississippi River; Hydraulic Investigation, by H. B. Simmons and H. J. Rhodes
TR 2-735		Model Studies of Navigation Improvements, Columbia River Estuary:
	Dec 1968	Report 1 Hydraulic and Salinity Verification, by F. A. Herrmann, Jr.
		Report 2 Entrance Studies:
	Aug 1966	Section 1 Fixed-Bed Studies of South Jetty Rehabilitation, by F. A. Herrmann, Jr., and H. B. Simmons
	Nov 1966	Section 2 Fixed-Bed Studies of North Jetty Rehabilitation, by F. A. Herrmann, Jr., and H. B. Simmons
	Apr 1972	Section 3 Fixed-Bed Studies of Disposal Areas C and D, by F. A. Herrmann, Jr.
	Jul 1974	Section 4 Jetty A Rehabilitation, Jetty B, and Outer Bar Channel Relocation, by F. A. Herrmann, Jr.
		Report 3 40-Ft Channel Studies:
	Feb 1971	Section 1 Wauna-Lower Westport Bar, by F. A. Herrmann, Jr.
TR H-69-2	Feb 1969	Model Study of Galveston Harbor Entrance, Texas; Hydraulic Model Investigation, by H. B. Simmons and R. A. Boland
TR H-69-16	Nov 1969	Channel Improvement, Fire Inlet, New York; Hydraulic Model Investigation, by W. H. Bobb and R. A. Boland

EM 1110-2-1607  
15 Mar 91

<u>Number</u>	<u>Date</u>	<u>Title</u>
TR H-72-2		Grays Harbor Estuary, Washington:
	Apr 1972	Report 1 Verification and Base Tests; Hydraulic Model Investigation; by N. J. Brogdon, Jr.
	May 1973	Appendix A Supplementary Base Test Data; Hydraulic Model Investigation, by N. J. Brogdon, Jr., and G. M. Fisackerly
	Sep 1972	Report 2 North Jetty Study; Hydraulic Model Investigation, by N. J. Brogdon, Jr.
	Sep 1972	Report 3 Westport Small-Boat Basin Study; Hydraulic Model Investigation, by N. J. Brogdon, Jr.
	Sep 1972	Report 4 South Jetty Study; Hydraulic Model Investigation, by N. J. Brogdon, Jr.
	Oct 1975	Report 5 Maintenance Studies of 35-Ft.-Deep (MSL) Navigation Channel; Hydraulic Model Investigation, by N. J. Brogdon, Jr.
	Apr 1976	Report 6 45-Ft. MSL (40-Ft. MLLW) Navigation Channel Improvement Studies; Hydraulic Model Investigation, by N. J. Brogdon, Jr.
TR H-74-1	Mar 1974	Navigation Channel Improvements, Barnegat Inlet, New Jersey; Hydraulic Model Investigation, by R. A. Sager and N. W. Hollyfield
TR H-76-4		Improvements for Masonboro Inlet, North Carolina; Hydraulic Model Investigation, by W. C. Seabergh
	Apr 1976	Volume I
	Apr 1976	Volume II
TR H-77-21	Nov 1977	Improvements for Little River Inlet, South Carolina; Hydraulic Model Investigation, by W. C. Seabergh and E. F. Lane

<u>Number</u>	<u>Date</u>	<u>Title</u>
TR H-78-4	Apr 1978	Improvements for Murrells Inlet, South Carolina; Hydraulic Model Investigation, by Maj. F. C. Perry, Jr., W. C. Seabergh, and E. F. Lane
TR HL-83-10	June 1983	Functional Design of Control Structures for Oregon Inlet, North Carolina; Hydraulic Model Investigation, by N. W. Hollyfield, J. W. McCoy, and W. C. Seabergh
	Mar 1985	Errata Sheet No. 1
TR HL-86-1	Jan 1986	Mississippi River Passes Physical Model Study; Report 2, Shoaling and Hydraulic Investigations in Southwest Pass; Hydraulic Model Investigation. By Howard A. Benson and Robert A. Boland
TR 2-711	Jan 1966	Matagorda Ship Channel Model Study, Matagorda Bay, Texas; Hydraulic Model Investigation, by H. J. Rhodes and H. B. Simmons
TR HL-88-16	July 1988	Advance Maintenance in Entrance Channels: Evaluation of Selected Projects; Hydraulic Model Investigation, by M. J. Trawle and J. A. Boyd
GITI 22	Feb 1982	Evaluation of Physical and Numerical Hydraulic Models, Masonboro Inlet, North Carolina, J. E. McTamany
TR HL-83-16		Columbia River Estuary Hybrid Model Studies
	Sep 1983	Report 1 Verification of Hybrid Modeling of the Columbia River Mouth, by W. H. McAnally, Jr., N. J. Brogdon, J. V. Letter, Jr., J. P. Stewart, and W. A. Thomas (includes Appendixes A-C)
	Sep 1983	Report 4 Entrance Channel Tests, by W. H. McAnally Jr., N. J. Brogdon, and J. P. Stewart

EM 1110-2-1607  
15 Mar 91

Hydraulic Model Studies  
I. A. 2. Estuaries, Bays and Rivers

<u>Number</u>	<u>Date</u>	<u>Title</u>
TR 2-694	Sep 1965	Hudson River Channel, New York and New Jersey; Plans to Reduce Shoaling in Hudson River Channel and Adjacent Pier Slips, by H. B. Simmons and W. H. Bobb
TR H-70-6	May 1970	Estuary Entrance, Umpqua River, Oregon; Hydraulic Model Investigation, by G. M. Fisackerly
TR H-72-9	Nov 1972	Navigation Channel Improvement, Gastineau Channel, Alaska; Hydraulic Model Investigation, by F. A. Herrmann, Jr.
TR H-74-12	Nov 1974	San Diego Bay Model Study; Hydraulic Model Investigation, by G. M. Fisackerly
TR HL-81-14	Dec 1981	Verification of the Chesapeake Bay Model, by N. W. Scheffner, L. G. Crosby, D. F. Bastian, A. M. Chambers and M. A. Granat
TR HL-82-3	Jan 1982	Low Freshwater Inflow Study, Chesapeake Bay Hydraulic Model Investigation, by D. R. Richards and L. F. Gulbrandsen
TR HL-82-5	Feb 1982	Baltimore Harbor and Channels Deepening Study; Chesapeake Bay Hydraulic Model Investigation, by M. A. Granat and L. F. Gulbrandsen
TR HL-83-13	Jun 1983	Norfolk Harbor and Channels Deepening Study, Report 1, Physical Model Results, Chesapeake Bay Hydraulic Model Investigation, by D. R. Richards and M. R. Morton
TR HL-84-10	Dec 1984	Dimensions for Safe and Efficient Deep-Draft Navigation Channels; Hydraulic Model Investigation, by H. O. Turner, Jr.
TR HL-85-3	Apr 1985	Reverification of the Chesapeake Bay Model, by M. A. Granat, L. F. Gulbrandsen and V. R. Pankow
TR HL-86-1	Jan 1986	Mississippi River Passes Physical Model Study; Report 2, Shoaling and Hydraulic Investigations in Southwest Pass, by H. A. Benson and R. A. Boland, Jr.

<u>Number</u>	<u>Date</u>	<u>Title</u>
MP HL-81-2	Jan 1981	Nanticoke River, Maryland Dye Dispersion Study, Chesapeake Bay Hydraulic Model Investigation, by D. R. Richards, S. R. River, and D. F. Bastian.
MP HL-86-7	Sep 1986	Estuary Model Test Evaluation, by N. J. Brogdon, Jr.



EM 1110-2-1607  
15 Mar 91

Hydraulic Model Studies  
I. A. 3. Harbors

<u>Number</u>	<u>Date</u>	<u>Title</u>
TR 2-444	Apr 1957	Investigation for Reduction of Maintenance Dredging in Charleston Harbor, South Carolina; Summary Report of Model Investigation
	Apr 1957	Appendix 1 Subsidiary Model Tests
	Apr 1957	Appendix 2 Data Plots
	Apr 1957	Appendix 3 Flow-Pattern Photographs
TR 2-580		Savannah Harbor Investigation and Model Study: Volume III Results of Model Investigations:
	Oct 1961	Section 1 Model Verification and Results of General Studies
	Oct 1961	Section 2 Tests of Improvement Plans
	Nov 1963	Section 3 Results of Supplemental Tests
	Mar 1965	Section 4 Results of Tests of Increased Channel Dimensions, by H. J. Rhodes H. B. Simmons
TR 2-733	Jul 1986	Reduction of Shoaling in Charleston Harbor and Navigation Improvement of Cooper River, South Carolina; Hydraulic Model Investigation, by W. H. Bobb and H. B. Simmons
TR H-75-4		Los Angeles and Long Beach Harbors Model Study
	Jun 1975	Report 1 Prototype Data Acquisition and Observations, by E. B. Pickett, D. L. Durham, and W. H. McAnally, Jr.
	Jan 1975	Report 2 Observations of Ship Mooring and Movement, by L. G. Crosby and D. L. Durham
	Jul 1976	Report 3 Analyses of Wave and Ship Motion Data, by D. L. Durham, J. K. Thompson, D. G. Outlaw, and L. G. Crosby

<u>Number</u>	<u>Date</u>	<u>Title</u>
	Feb 1977	Report 4 Model Design, by D. G. Outlaw, D. L. Durham, C. E. Chatham, and R. W. Whalin
	Feb 1978	Errata Sheet No. 1
	Sep 1975	Report 5 Tidal Verification and Base Circulation Tests, by W. H. McAnally, Jr. (includes Appendix A)
	Sep 1975	Appendix B Surface-Current Pattern Mosaics, by W. H. McAnally, Jr.
	Aug 1979	Report 6 Resonant Response of the Modified Phase I Plan, by D. G. Outlaw
TR H-78-18	Nov 1978	Design for Harbor Entrance Improvements, Wells Harbor, Maine, Hydraulic Model Investigation, by R. R. Bottin, Jr.
TR HL-83-13		Norfolk Harbor and Channels Deepening Study:
	Jun 1983	Report 1 Physical Model Results; Chesapeake Bay Hydraulic Model Investigation, by D. R. Richards and M. R. Morton
	Mar 1985	Report 2 Sedimentation Investigation; Chesapeake Bay Hydraulic Model Investigation, by R. C. Berger, Jr., S. B. Heltzel, R. F. Athow, Jr., D. R. Richards, and M. J. Trawle (includes Appendix A)

EM 1110-2-1607  
15 Mar 91

Hydraulic Model Studies  
I. A. 4. Dredging and Dredged Material Disposal

Number	Date	Title
TR 2-755	Jan 1967	Model Study of Hopper Dredges; Hydraulic Model Investigation, by J. J. Franco
TR H-72-5	Sep 1972	Plans for Reduction of Shoaling in Brunswick Harbor and Jekyll Creek, Georgia; Hydraulic Model Investigation, by F. A. Herrmann, Jr. and I. C. Tallant
TR H-72-8	Nov 1972	Disposal of Dredge Spoil; Problem Identification and Assessment and Research Program Development, by M. B. Body et. al.
TR H-73-12		Houston Ship Channel, Galveston Bay, Texas:
	Aug 1973	Report 1 Hydraulic and Salinity Verification; Hydraulic Model Investigation, by W. H. Bobb, R. A. Boland, Jr., and A. J. Banchetti
TR H-75-13		Mobile Bay Model Study:
	Sep 1975	Report 1 Effects of Proposed Theodore Ship Channel and Disposal Areas on Tides, Currents, Salinities, and Dye Dispersion, by R. J. Lawing, R. A. Boland, Jr., and W. H. Bobb (includes Appendixes A-B)
TR H-78-5		Effects of Depth on Dredging Frequency:
	May 1978	Report 1 Survey of District Offices, by M. J. Trawle and J. A. Boyd, Jr.
	Jul 1981	Report 2 Methods of Estuarine Shoaling Analysis, by M. J. Trawle
TR HL-84-6	Jul 1984	Agitation Dredging: Lessons and Guidelines from Past Projects, by T. W. Richardson (includes Appendixes A-B)

Hydraulic Model Studies  
I. B. 1. Storm Surge Barriers

<u>Number</u>	<u>Date</u>	<u>Title</u>
Unnumbered		Model Study of Narragansett Bay:
	Feb 1957	Interim Report Protection of Narragansett Bay from Hurricane Tides; Hydraulic Model Investigation
	Jan 1959	Interim Report 2 Effects of Lower Bay Barriers on Salinities, Shoaling and Pollution in Narragansett Bay; Hydraulic Model Investigation
	Sep 1959	Interim Report 3 Effects of Fox Point Barrier on Water Temperatures
	Sep 1959	Interim Report 4 Effects on Cooling-Water Channel on Temperatures of Cooling Water for Power Stations
TR 2-636	Nov 1963	Effects on Lake Pontchartrain, Louisiana, of Hurricane Surge Control Structures and Mississippi River-Gulf Outlet Channel; Hydraulic Model Investigation
TR 2-662	Oct 1964	Protection of Narragansett Bay from Hurricane Surges; Summary Report; Hydraulic Model Investigation, H. B. Simmons
TR 2-663	Oct 1964	Discharge Characteristics of Hurricane Barriers, Wareham-Marion, Massachusetts; Hydraulic Model Investigation, by E. C. McNair, Jr., and J. L. Grace
TR 2-742	Oct 1966	Steady-flow Stability Tests of Navigation Opening Structures, Hilo Harbor Tsunami Barrier, Hilo, Hawaii; Hydraulic Model Investigation, by N. R. Oswalt and M. B. Boyd
TR 2-754	Jan 1967	Effects of Hurricane Barrier on Navigation Conditions in East Passage, Narragansett Bay, Rhode Island; Hydraulic Model Investigation, by J. G. Housley
TR H-69-12		Galveston Bay Hurricane Surge Study:

EM 1110-2-1607  
 15 Mar 91

<u>Number</u>	<u>Date</u>	<u>Title</u>
	Sep 1969	Report 1 Effects of Proposed Barriers on Hurricane Surge Heights; Hydraulic Model Investigation, by N. J. Brogdon, Jr.
	Mar 1973	Appendix A Calibration Tests; Hydraulic Model Investigation, by R. A. Sager and E. C. McNair, Jr.
	Jul 1970	Report 2 Effects of Proposed Barriers on Tides, Currents, Salinities, and Dye Dispersion for Normal Tide Conditions, by W. H. Bobb and R. A. Boland, Jr.
	Jul 1970	Appendix A Dye Time-Concentration Curves
	Mar 1973	Appendix B Calibration Tests: Hydraulic Model Investigation, by R. A. Sager and E. C. McNair, Jr.
	Jul 1970	Report 3 Effects of Plan 2 Alpha and Plan 2 Gamma Barriers on Tides, Currents, Salinities, and Dye Dispersion for Normal Tide Conditions; Hydraulic Model Investigation, by W. H. Bobb and R. A. Boland, Jr.
	Jul 1970	Appendix A Dye-Time Concentration Curves
TR H-76-14	Sep 1976	Effects of Hurricane Surge Barrier on Hydraulic Environment, Jamaica Bay, New York; Hydraulic Model Investigation, by R. F. Athow, Jr.
TR H-76-16	Sep 1976	Hydraulic Characteristics of Rigolets Pass, Louisiana, Hurricane Surge Control Structures; Hydraulic Model Investigation, by R. C. Berger, Jr., and R. A. Boland, Jr. (includes Appendix A)
TR HL-82-2		Lake Pontchartrain and Vicinity Hurricane Protection Plan:
	Jan 1982	Report 1 Prototype Data Acquisition and Analysis, by D. G. Outlaw (includes Appendixes A-E)
	Jun 1982	Report 2 Physical and Numerical Model Investigation of Control Structures and the

<u>Number</u>	<u>Date</u>	<u>Title</u>
		Seabrook Lock; Hydraulic and Mathematical Model Investigation; by H. L. Butler, R. C. Berger, L. L. Daggett, and T. F. Berninghausen
	Oct 1983	Report 3 Numerical Model Investigation of Plan Impact on the Tidal Prism of Lake Pontchartrain, by H. L. Butler (includes Appendixes A-B)
MP H-72-1	Apr 1972	Physical Model Studies of Proposed Hurricane Surge Protection Schemes, by N. J. Brogdon and F. A. Herrmann, Jr.

EM 1110-2-1607  
15 Mar 91

Hydraulic Model Studies  
I. C. 1. Saltwater Intrusion

<u>Number</u>	<u>Date</u>	<u>Title</u>
TM 2-310	Apr 1950	Salt Water Intrusion, Calcasieu River, Louisiana, and Connecting Waterways; Model Investigation.
TR HL-79-18	Nov 1979	Carquinez Strait, California, Salinity Barrier Calibration Study; Hydraulic Model Investigation, by R. C. Berger, Jr. (includes Appendixes A-B)

Hydraulic Model Studies  
I. C. 2. Sedimentation

<u>Number</u>	<u>Date</u>	<u>Title</u>
TR HL-82-15		The Atchafalaya River Delta:
	June 1988	Report 2 Field Data
		Section 1 Atchafalaya Bay Program Description and Data (2 volumes) by C. J. Coleman, A. M. Teeter, B. P. Donnell, G. M. Fisackerly, D. A. Crouse and J. W. Parman.
	Sep 1989	Section 2 Settling Characteristics of Bay Sediments by A. M. Teeter and W. Pankow.
	Jul 1982	Report 3 Extrapolation of Delta Growth, by J. V. Letter, Jr.
	Jan 1984	Report 4 Generic Analysis of Delta Development, by J. T. Wells, S. J. Chinburg, and J. M. Coleman (includes Appendixes A-B)
	Dec 1988	Report 5 The Atchafalaya River Delta Quasi-Two-Dimensional Model of Delta Growth and Impacts on River Stages, by W. A. Thomas, R. E. Heath, J. P. Stewart and D. G. Clark.

<u>Number</u>	<u>Date</u>	<u>Title</u>
	Jul 1984	Report 6 Interim Summary Report of Growth Predictions, by W. H. McAnally, Jr., W. A. Thomas, J. V. Letter, Jr., and J. P. Stewart
	Sep 1985	Report 7 Analytical Analysis of the Development of the Atchafalaya River Delta
	Jan 1985	Report 9 Wind Climatology, by B. A. Ebersole
GITI 12	May 1977	A Case History of Port Mansfield Channel, Texas, by J. M. Kieslich



EM 1110-2-1607  
15 Mar 91

Hydraulic Model Studies  
I. C. 3. Currents, Tides, Dispersion and Flushing

Number	Date	Title
TR 2-457	Jun 1957	Dispersion of Effluent in Delaware River from New Jersey Zinc Company Plant; Hydraulic Model Investigation
TR 2-767	Apr 1967	Magic Island Complex, Including Kewalo Basin and Ala Wai Boat Harbor, Honolulu, Oahu, Hawaii; Hydraulic Model Investigation, by C. W. Brasfeild and C. E. Chatham, Jr.
TR H-74-11	Nov 1974	Tillamook Bay Model Study; Hydraulic Model Investigation, by G. M. Fisackerly
TR HL-79-1		Newburport Harbor, Massachusetts:
	Feb 1979	Report 1 Design for Wave Protection and Erosion Control, by C. R. Curren and C. E. Chatham, Jr. (includes Appendix A)
TR HL-79-12		Mayport-Mill Cove Model Study:
	Jul 1979	Report 1 Hydraulic, Salinity, and Shoaling Verification; Hydraulic Model Investigation, by N. J. Brogdon, Jr.
	Aug 1979	Report 2 Mayport Naval Basin Study; Hydraulic Model Investigation, by N. J. Brogdon, Jr.
	Sep 1979	Report 3 Mill Cove Study; Hydraulic Model Investigation, by N. J. Brogdon, Jr. and J. W. Parman
TR HL-79-15	Sep 1979	San Juan National Historic Site, San Juan, Puerto Rico; Design for Prevention of Wave-Induced Erosion; Hydraulic Model Investigation, by R. R. Bottin, Jr. (includes Appendixes A-B)
TR HL-81-14	Dec 1981	Verification of the Chesapeake Bay Model; Chesapeake Bay Hydraulic Model Investigation, by N. W. Scheffner, L. G. Crosby, D. F. Bastian, A. M. Chambers, and M. A. Granat (includes Appendixes A-D)

<u>Number</u>	<u>Date</u>	<u>Title</u>
TR HL-82-3	Jan 1982	Low Freshwater Inflow Study; Chesapeake Bay Hydraulic Model Investigation, by D. R. Richards and L. F. Gulbrandsen
	Mar 1982	Errata Sheet No. 1
TR HL-85-3	Apr 1985	Reverification of the Chesapeake Bay Model; Chesapeake Bay Hydraulic Model Investigation, by M. A. Granat, L. F. Gulbrandsen, and V. R. Pankow (includes Appendixes A-D)
MP 2-812	Apr 1966	Flushing Studies, Victoria Channel, Victoria, Texas; Hydraulic Model Investigation, by R. A. Boland
MP 2-912	Sep 1966	Effects of a Proposed 35-Foot Channel to Richmond on Currents and Salinities Over the Seed Oyster Beds in James River; Hydraulic Model Investigation, by W. H. Bobb, N. J. Brogdon, and H. B. Simmons
MP H-69-13	Dec 1969	Effects of Proposed Elizabeth River Dike on Tides, Currents, Salinities, and Shoaling; Hydraulic Model Investigation, by R. A. Boland and W. H. Bobb
MP H-72-8	Jun 1972	Effects of Proposed Extension of Craney Island Disposal Area on Tides, Currents, and Salinities; Hydraulic Model Investigation, by R. A. Boland
MP H-76-9	May 1976	Effects of 40-Foot Charleston Harbor Project on Tides, Currents, and Salinities; Hydraulic Model Investigation, by H. A. Benson
MP H-77-3	Mar 1977	Dispersion of Proposed Theodore Industrial Park Effluents in Mobile Bay; Hydraulic Model Investigation, by R. C. Berger, Jr., and M. J. Trawle
MP H-78-6		Georgetown Harbor, South Carolina:
	Feb 1978	Report 1 Hydraulic, Salinity, and Shoaling Verification; Hydraulic Model Investigation, by M. J. Trawle
	May 1979	Report 2 Effects of Various Channel Schemes on Tides, Currents, and Shoaling;

EM 1110-2-1607  
15 Mar 91

<u>Number</u>	<u>Date</u>	<u>Title</u>
		Hydraulic Model Investigation, by M. J. Trawle and R. A. Boland, Jr.
GITI 13	Aug 1977	Hydraulics and Stability of Tidal Inlets, by F. F. Escoffier
GITI 15	Nov 1977	Physical Model Simulation of the Hydraulics of Masonboro Inlet, North Carolina, R. A. Sager and W. C. Seaberg
GITI 16	Sep 1978	Hydraulics and Dynamics of North Inlet, South Carolina, 1975-76, D. Nummedal and S. M. Humphries
GITI 17	Feb 1979	An Evaluation of Movable-Bed Tidal Inlet Models, S. C. Jain and J. F. Kennedy
GITI GI 18	May 1980	Supplementary Tests of Mosonboro inlet Fixed-Bed Model: Hydraulic Model Investigation, W. C. Seabergh and R. A. Sager

Numerical Model and Analytical Study  
II. A. 1. Hybrid Models

<u>Number</u>	<u>Date</u>	<u>Title</u>
TR H-73-16	Oct 1973	Enlargement of the Chesapeake and Delaware Canal; Hydraulic and Mathematical Model Investigation, by M. B. Body, W. H. Bobb, C. J. Huvall, and T. C. Hill
TR HL-83-16		Columbia River Estuary Hybrid Model Studies
	Sep 1983	Report 1 Verification of Hybrid Modeling of the Columbia River Mouth, by W. H. McAnally, Jr., N. J. Brogdon, J. V. Letter, Jr., J. P. Stewart, and W. A. Thomas (includes Appendixes A-C)
	Sep 1983	Report 4 Entrance Channel Tests, by W. H. McAnally Jr., N. J. Brogdon, and J. P. Stewart
TR HL-89-14	Jul 1989	Verification of the Hydrodynamic and Sediment Transport Hybrid Modeling System for Cumberland Sound and Kings Bay Navigation Channel, Georgia, by M. A. Granat, N. J. Brogdon, J. T. Cartwright and W. H. McAnally, Jr.
GITI 19	Oct 1981	Tidal Inlet Response to Jetty Construction, Kieslich, J. M.

EM 1110-2-1607  
 15 Mar 91

Mathematical Model  
 II. A. 2. Studies

<u>Number</u>	<u>Date</u>	<u>Title</u>
TR H-78-22	Dec 1978	Numerical Simulation of the Coos Bay-South Slough Complex, by H. L. Butler
TR HL-87-1	Apr 1987	A Mathematical Study of the Impact on Salinity Intrusion of Deepening the Lower Mississippi River Navigation Channel, by B. H. Johnson, M. B. Boyd and G. H. Keulegan
TR HL-87-13	Sep 1987	Corpus Christi Inner Harbor Shoaling Investigation, by T. M. Smith, W. H. McAnally Jr. and A. M. Teeter
TR HL-88-8	Apr 1988	Lower James River Circulation Study, Virginia, Evaluation of Craney Island Enlargement Alternatives, by S. B. Heltzel and M. A. Granat
TR HL-88-24	Sep 1988	New Haven Harbor Numerical Model Study, by D. R. Richards and J. E. Clausner
TR HL-88-25	Sep 1988	I-664 Bridge-Tunnel Study, Virginia, Sedimentation and Circulation Investigation, by S. B. Heltzel
TR HL-89-3	Feb 1989	Effects of Cooper Rediversion Flows on Shoaling Conditions at Charleston Harbor, Charleston, South Carolina, by A. M. Teeter
TR HL-89-12	Jun 1989	Newport News Channel Deepening Study, Virginia; Numerical Model Investigation, by H. J. Lin and W. D. Martin
MP HL-87-2	Jun 1987 Sep 1988	A Numerical Model Analysis of Mississippi River Passes Navigation Channel Improvements, by D. R. Richards, et al (in four reports)
GITI 6	Jun 1977	Comparison of Numerical and Physical Hydraulic Models, Masonboro Inlet, North Carolina, Main text and Appendixes 1-4, D. L. Harris and B. R. Bodine
	Jun 1977	Appendix 1 Fixed-Bed Hydraulic Model Results, R. A. Sager and W. C. Seabergh
	Jun 1977	Appendix 2 Numerical Simulation of Hydrodynamics (WRE), F. D. Masch,

<u>Number</u>	<u>Date</u>	<u>Title</u>
		R. J. Brandes and J. D. Reagan (in 2 Volumes)
	Jun 1977	Appendix 3 Numerical Simulation of Hydrodynamics (Tractor), R. J. Chen and L. A. Hembree, Jr.
	Jun 1977	Appendix 4 Simplified Numerical (Lumped Parameter) Simulation, C. J. Huval G. L. Wintergerst
TR CERC-83-2	Sep 1983	Mathematical Modeling of Three-Dimensional Coastal Currents and Sediment Dispersion: Model Development and Application, Y. P. Sheng

II. A. 3. Ship Simulation Studies

<u>Number</u>	<u>Date</u>	<u>Title</u>
TR HL-85-4	Jun 1985	Ship Simulation Study of John F. Baldwin (Phase II) Navigation Channel, San Francisco Bay, California, by C. Huval, B. Comes, and R. T. Garner III.
TR HL-87-5	May 1987	Ship Navigation Simulator Study; Savannah Harbor Widening Project, Savannah, Georgia, by J. C. Hewlett, L. L. Daggett and S. B. Heltzel

EM 1110-2-1607  
15 Mar 91

Hurricane Studies  
II. B. 1. Storm Surge Height

<u>Number</u>	<u>Date</u>	<u>Title</u>
TR HL-79-2	Feb 1979	A Numerical Model for Tsunami Inundation, by J. R. Houston and H. L. Butler (includes Appendix A)
TR H-77-17	Sep 1977	Nearshore Numerical Storm Surge and Tidal Simulation, by J. J. Wanstrath
TR HL-82-15	Jan 1985	Report 8 Numerical Modeling of Hurricane-Induced Storm surge, by B. A. Ebersole
TR 76-3	Nov 1976	"Theory and Application," Storm Surge Simulation in Transformed Coordinates, Wanstrath, J. J., et. al.
	Nov 1976	"Program Documentation," Storm Surge Simulation in Transformed Coordinates, Wanstrath, J. J.
TR HL-80-18	Sep 1980	Type 19 Flood Insurance Study: Tsunami Predictions for Southern California, by J. R. Houston (includes Appendixes A-B)
CTH Technical Bulletin No. 21	Dec 1980	Evaluation of Numerical Storm Surge Models

Hydrodynamic Simulations  
II. C. 1. Salt Water Intrusion

<u>Number</u>	<u>Date</u>	<u>Title</u>
WES Video File No. 88153	1988	Video Report - "Saltwater Intrusion Demonstration" by N. J. Brogdon, et al.

II. C. 2. Sedimentation Simulation

<u>Number</u>	<u>Date</u>	<u>Title</u>
TR 82-4	Oct 1982	Performance of a Sand Trap Structure and Effects of Impounded Sediments, Channel Islands Harbor, California, R. D. Hobson
TR HL-85-5	Sep 85	Spectral Analysis of River Columbia Estuary Currents, B. P. Donnell and W. H. McAnally, Jr.
GITI 5	Feb 1976	Notes on Tidal Inlets on Sandy Shores, M. P. O'Brien
GITI 12	May 1977	A Case History of Port Mansfield Channel, Texas, J. M. Kieslich



EM 1110-2-1607  
15 Mar 91

II. C. 3. Currents, Tides, Dispersion and Flushing

<u>Number</u>	<u>Date</u>	<u>Title</u>
TR H-69-9	Jun 1969	Theoretics in Design of the Proposed Crescent City Harbor Tsunami Model, by G. H. Keulegan, J. Harrison, and M. J. Mathews
TR H-78-11	Jun 1978	Numerical Simulation of Tidal Hydrodynamics, Great Egg Harbor and Corson Inlets, New Jersey, by H. L. Butler (includes Appendixes A-E; Appendix E is on microfiche only)
TR HL-80-3		Erosion Control of Scour During Construction:
	Sep 1984	Report 6 FINITE - A Numerical Model for Combined Refraction and Diffraction of Waves, by J. R. Houston and L. W. Chou (includes Appendix A)
	Sep 1984	Report 7 CURRENT - A Wave-Induced Current Model, by S. R. Vemulakonda (includes Appendix A)
TR CERC-84-2	Apr 1984	Numerical Simulation of Oregon Inlet Control Structures, Effects on Storm and Tide Elevations in Pamlico Sound, D. L. Leenknecht, J. A. Earickson, and H. L. Butler
GITI 14	Nov 1977	A Spatially Integrated Numerical Model of Inlet Hydraulics, W. N. Seelig, D. L. Harris and B. E. Herchenrodeer
SR 7	Feb 1981	Tides and Tidal Datums in the United States, D. L. Harris. (GPO Stock No. 008-022-00161-1)

Dredging Related Studies  
II. D. 1. Dredged Material Disposal

Number	Date	Title
TR HL-87-12	Sep 1987	Technical Supplement to Dredged Material Disposal Study US Navy Home Port, Everett Washington, by S. A. Adamec, Jr., B. H. Johnson, A. M. Teeter and M. J. Trawle
TR HL-88-27	Nov 1988	San Francisco Bay: Modeling System for Dredged Material Disposal and Hydraulic Transport, by V. R. Pankow
TR HL-89-11	May 1989	Deposition and Erosion Testing on the Composite Dredged Material Sediment Sample from New Bedford Harbor, Massachusetts, by A. M. Teeter and W. Pankow.
MP HL-86-1	Mar 1986	Alcatraz Disposal Site Investigation, Report 1, by M. J. Trawle and B. H. Johnson
MP HL-86-1	Oct 1986	Report 2, North Zone Disposal of Oakland Outer Harbor and Richmond Inner Harbor Sediments, by M. J. Trawle
MP HL-86-1	May 1987	Report 3, San Francisco Bay - Alcatraz Disposal Site Erodibility, by A. M. Teeter
MP HL-86-5	Aug 1986	Puget Sound Generic Dredged Material Disposal Alternatives, by M. J. Trawle and B. H. Johnson
TR EL-88-15	Dec 1988	New Bedford Harbor Superfund Project, Report 2, Sediment and Contaminant Hydraulic Transport Investigations, by A. M. Teeter